

**ADEMCO VISTA SERIES
VISTA-128BP/VISTA-250BP/
VISTA-128SIA**

**Commercial Burglary
Partitioned Security System
With Scheduling**

Programming Guide

Table of Contents

Recommended Programming Procedure.....	3	Relay Voice Descriptors	39
Program Field Index.....	4	Relay Voice Descriptors and Custom Word Substitutes Vocabulary	40
VISTA-128BP/VISTA-250BP Programming Form	5	Custom Word Substitutes for VIP Module Annunciation .	40
Partition-Specific Fields	12	Scheduled Check-in	41
Programming With #93 Menu Mode	14	System Layout Worksheets	42
Zone Programming.....	15	Output Devices Worksheets	57
5800 Series Transmitters Loop Designations.....	19	Scheduling Menu Prompts.....	63
Expert Mode Zone Programming	20	Scheduling Worksheets.....	64
Report Code Programming	24	VISTA-128BP Summary of Connections Diagram	69
Alpha Descriptors Programming.....	27	VISTA-250BP Summary of Connections Diagram	70
Alpha Descriptor Vocabulary.....	31	VISTA-128SIA Summary of Connections Diagram	71
Device Programming	32		
Output Programming	35		

NOTE: All references to the VISTA-128BP also pertain to the VISTA-128SIA. The differences between the two panels are outlined in the supplement accompanying the VISTA-128SIA. The supplement must be referred to when programming the VISTA-128SIA. All references in this manual for number of zones, number of user codes, number of access cards, and the event log capacity, use the VISTA-250BP's features. The following table lists the differences between the VISTA-128BP/128SIA and the VISTA-250BP control panels. All other features are identical, except for the Remote Keypad Sounder (field 1*46 option 2), which is available only in the VISTA-128BP/128SIA.

Feature	VISTA-128BP/128SIA	VISTA-250BP
Number of Zones	128	250
Number of User Codes	150	250
Number of Access Cards	250	500
Event Log Capacity	512	1000
VistaKey Modules	8	15

The purpose of this document is to provide a quick and easy way to program your entire system. A recommended programming procedure is included, followed by a list of program fields with the corresponding program group they belong to (system-wide, partition-specific, scheduling, etc.). Two program forms are included. One contains all the programming fields, and the other contains the partition-specific fields. If you are setting up a single-partition system, the partition-specific fields become system-wide fields.

Following the program forms are system layout worksheets. We recommend that you use these sheets to plan your system before programming is performed. If you need further information about specific programming options, see the *VISTA-128BP/VISTA-250BP Installation and Setup Guide*.

Make sure that one two-line alpha keypad is connected to the control and is set to device address "00."

Single-Partition System

The system default is for a single-partition system. Use the VISTA-128BP/VISTA-250BP SINGLE PARTITION PROGRAMMING FORM when programming for single-partition usage. Follow the steps outlined in RECOMMENDED PROGRAMMING PROCEDURE of this document for proper programming procedure.

Multiple-Partition System

You must enter the number of partitions you are using in data field 2*00 to set the system for multiple partitions. Use the VISTA-128BP/VISTA-250BP SINGLE PARTITION and the PARTITION-SPECIFIC PROGRAM FORMS when programming the system for multiple partitions. Follow the steps outlined in RECOMMENDED PROGRAMMING PROCEDURE of this document for proper programming procedure.

SUMMARY OF PROGRAMMING COMMANDS

- **To enter program mode**, enter installer code + [8] + [0] + [0] + [0]
- **To set standard defaults**, press *97
- **To change to next page of program fields**, press *94
- **To return to previous set of fields**, press *99
- **To erase account and phone number field entries**, press [*] + field number + [*]
- **To assign zone descriptors**, press #93 + follow menu prompts
- **To add custom words**, press #93 + follow menu prompts
- **To enter Installer's Message**, press #93 + follow menu prompts
- **To exit program mode**, enter *99 OR *98: *99 allows re-access to programming mode by installer code. *98 prevents re-access to programming mode by installer code.

Standard default (*97) values are shown in brackets [], otherwise default = 0.

Recommended Programming Procedure

The following is a step-by-step procedure recommended for programming your VISTA-128BP/VISTA-250BP/VISTA-128SIA systems.

NOTE: To program the VISTA-128SIA you must use the supplement in conjunction with this manual. All items labeled "SIA Guidelines" in the manual pertain to the VISTA-128BP and VISTA-250BP only. All SIA related information for the VISTA-128SIA is included in the supplement.

- 1. Set the keypads (and other peripheral devices) to the appropriate addresses.**
- 2. Set factory defaults by pressing *97.**

This will automatically enable keypad addresses 00-01, so be sure at least one keypad is set to one of these addresses. Address 01 is also set for AUI.
- 3. Program system-wide (global) data fields.**

Using the programming form as a guide, enter program mode and program all system-wide programming fields. These options affect the entire system, regardless of partitions. They include control options, downloader and dialer options, RF options, event logging options, etc. Refer to the *Program Field Index* for a listing of the program fields and their function. **Note that field 2*00 (number of partitions) must be programmed before continuing.**
- 4. Program partition-specific fields.**

When the system-wide fields have been programmed, program all partition-specific programming fields by first pressing *91 to select a partition (while still in data field program mode). Then enter the first partition-specific field number *09. When you are finished, the next partition-specific field is automatically displayed. Partition-specific fields can have different values for each partition. To program the fields for the next partition, press *91, enter the desired partition number, then enter field *09. Refer to the *MECHANICS OF PROGRAMMING* section in the *VISTA-128BP/VISTA-250BP Installation and Setup Guide* for detailed instructions.
- 5. Use #93 Menu Mode for device programming.**

Refer to *Device Programming* in this guide to assign keypad ID numbers and default partitions for each keypad, and to selectively suppress certain keypad sounding options. Also use this mode to assign RF receivers, relay modules, the VIP module, the ECP Long Range Radio, and the VISTA Gateway Module.
- 6. Use #93 Menu Mode for zone programming.**

Refer to *Zone Programming* in this guide to program zone response types, assign right loop zones and wireless zones, assign zones to partitions, and to program alarm report codes.
- 7. Use #93 Menu Mode for programming outputs.**

Refer to *Output Programming* in this guide to program desired output operation.
- 8. Program Communication options.**

Refer to *System Communication* section in the *VISTA-128BP/VISTA-250BP Installation and Setup Guide* for detailed instructions. Then use #93 menu mode to program report codes.
- 9. Use #93 Menu Mode for programming alpha descriptors.**

Refer to *Alpha Programming* in this guide to enter zone and partition descriptors and a custom installer's message.
- 10. Use #93 Menu Mode for relay voice descriptors and custom word substitutes.**

Refer to *Relay Voice Descriptors* in this guide for further instructions for programming relay descriptors to be annunciated by the VIP module, as well as the *Custom Index* section for custom word substitutes.
- 11. Use #80 Mode for programming schedules.**

Refer to the *Scheduling Menu Prompts* in the *VISTA-128BP/VISTA-250BP Installation and Setup Guide* to program open/close schedules, temporary and holiday schedules, limitation of access schedules, and time-driven events.
- 12. Define user access codes.**

Refer to *User Access Codes* in the *VISTA-128BP/VISTA-250BP Installation and Setup Guide* to program authority level, O/C reporting option, partition assignments, and RF key assignments for each user.
- 13. Exit Programming Mode.**

Exit programming mode by pressing either *98 or *99. Additional entries of *99 are required if the exit is being done from fields 1*00 and above.

To prevent re-access to programming mode using the Installer's code, use *98. The only way to re-access programming mode is by depressing both the [*] and [#] keys at the same time within 30 seconds of power-up.

Exiting by using *99 always allows reentry into programming mode using the Installer code. Either way of exiting allows access via downloading. Note that if local programming lockout is set via downloading, programming mode cannot be entered at the keypad.

Program Field Index

On the following pages, the programming fields have been arranged in numerical order. Use this index to cross-reference the fields on the programming form.

Field	Group	Field	Group	Field	Group
*00	System-Wide	*90	Partition-Specific	2*30	Communications
*04	System-Wide	1*07	System-Wide	2*31	Communications
*05	System-Wide	1*10	System-Wide	2*32	Communications
*06	Partition-Specific	1*15	Communications	2*33	Communications
*09	Partition-Specific	1*17	System-Wide	2*34	Communications
*10	Partition-Specific	1*18	Partition-Specific	2*35	Communications
*11	Partition-Specific	1*19	Partition-Specific	2*36	Communications
*12	Partition-Specific	1*20	System-Wide	2*37	Communications
*13	Partition-Specific	1*21	System-Wide	2*38	Communications
*14	System-Wide	1*22	System-Wide	2*39	Communications
*15	System-Wide	1*23	System-Wide	2*40	Communications
*16	Partition-Specific	1*24	System-Wide	2*41	Communications
*17	System-Wide	1*25	System-Wide	2*42	Communications
*19	System-Wide	1*26	Partition-Specific	2*43	Communications
*20	System-Wide	1*28	System-Wide	2*44	Communications
*21	System-Wide	1*29	System-Wide	2*45	Communications
*22	Partition-Specific	1*30	System-Wide	2*46	Communications
*23	Partition-Specific	1*31	System-Wide	2*47	Communications
*24	System-Wide	1*33	Communications	2*48	Communications
*25	System-Wide	1*34	Communications	2*49	Communications
*26	Communications	1*35	communications	2*50	Communications
*27	Communications	1*42	Communications	2*51	Communications
*28	System-Wide	1*43	Partition-Specific	2*52	Communications
*29	Partition-Specific	1*44	System-Wide	2*53	Communications
*30	Communications	1*45	Partition-Specific	2*54	Communications
*31	Communications	1*46	System-Wide	2*55	Communications
*32	Partition-Specific	1*47	Partition-Specific	2*56	Communications
*33	Communications	1*48	System-Wide	2*57	Communications
*34	Communications	1*49	System-Wide	2*58	Communications
*35	System-Wide	1*52	Partition-Specific	2*59	Communications
*36	System-Wide	1*53	System-Wide	2*60	Communications
*37	System-Wide	1*55	System-Wide	2*61	Communications
*38	Partition-Specific	1*56	System-Wide	2*62	Communications
*39	Partition-Specific	1*57	System-Wide	2*63	Communications
*40	Communications	1*58	System-Wide	2*64	Communications
*41	System-Wide	1*60	System-Wide	2*65	Communications
*42	Communications	1*69	System-Wide	2*66	Communications
*43	Communications	1*70	System-Wide	2*67	Communications
*44	Communications	1*71	System-Wide	2*68	Communications
*45	Communications	1*72	System-Wide	2*69	Communications
*46	Communications	1*73	System-Wide	2*70	Communications
*47	Communications	1*74	System-Wide	2*71	Communications
*48	Communications	1*75	System-Wide	2*72	Communications
*49	Communications	1*76	Partition-Specific	2*73	Communications
*50	Communications	2*00	System-Wide	2*74	Communications
*51	Communications	2*01	System-Wide	2*75	Communications
*52	Communications	2*02	System-Wide	2*76	Communications
*53	Communications	2*05	Partition-Specific	2*77	Communications
*54	System-Wide	2*06	Partition-Specific	2*78	Communications
*56	Communications	2*07	Partition-Specific	2*79	Communications
*57	Communications	2*08	Partition-Specific	2*80	Communications
*58	Communications	2*09	Partition-Specific	2*81	Communications
*59	Communications	2*10	Partition-Specific	2*82	Communications
*79	Communications	2*11	System-Wide	2*83	Communications
*80	Communications	2*18	Partition-Specific	2*84	Communications
*83	Communications	2*19	System-Wide	2*85	Communications
*84	Partition-Specific	2*20	Partition-Specific	2*86	Communications
*85	Partition-Specific	2*21	System-Wide	2*87	Communications
*87	Partition-Specific	2*22	Partition-Specific	2*88	Communications
*88	Partition-Specific	2*23	Partition-Specific		
*89	Communications	2*24	Partition-Specific		

VISTA-128BP/VISTA-250BP Programming Form

Some fields are programmed for each partition (shown as shaded fields). If you are programming a multiple-partition system, see the *Partition-Specific Fields* section for programming these fields. Standard default (*97) values are shown in brackets []; otherwise, default = 0.

***00** INSTALLER CODE
Enter 4 digits, 0-9 [4140]

***04** ENABLE RANDOM TIMERS

 1 2 3 4 5 6 7 8
 Enter 1 to make available the randomizing of pre-programmed time driven events for each partition. [0=disable].

***05** SYSTEM EVENTS NOTIFY [0]
 1=yes, (messages sent via the RS232 port).
 0=no, (no messages sent).

***06** QUICK EXIT [1]
 1=enable; 0=disable
 Must be 0 for UL installations.

***09** ENTRY DELAY #1 [02]
 00, 02-15 times 15 seconds
 Maximum "03" for UL.
 SIA Guidelines: The entry delay time and Burg Alarm Comm Delay (field *88) combined cannot exceed 1 minute.

***10** EXIT DELAY #1 [04]
 00, 03-15 times 15 seconds
 Maximum "04" for UL installations.
 SIA Guidelines: Minimum 45 seconds "03".

***11** ENTRY DELAY #2 [02]
 00, 02-15 times 15 seconds (must be longer than Entry Delay #1). Maximum "03" for UL installations.
 SIA Guidelines: The entry delay time and Burg Alarm Comm Delay (field *88) combined cannot exceed 1 minute.

***12** EXIT DELAY #2 [08]
 00, 03-15 times 15 seconds (must be longer than Exit Delay #1). Maximum "04" for UL installations.
 SIA Guidelines: Minimum 45 seconds "03".

***13** ALARM SOUNDER DURATION [04]
 01-15 times 2 minutes. Must be minimum 16 minutes for UL installations. SIA Guidelines: Must be minimum 6 minutes.

***14** BURGLARY OR RS232 INPUT [0]
 Enter 1 to set terminal 23 as a RS232 input to enable system to receive serial data (75 baud) via terminal 23.
 Enter 0 to enable terminal 23 as burglary input for zone 9.

***15** KEYSWITCH ASSIGNMENT [0]
 Enter partition in which keyswitch used,
 1-8; 0=disable

***16** CONFIRMATION OF ARMING DING [0]
 1=enable; 0=disable.
 Must be "1" for UL Installations.

***17** AC LOSS KEYPAD SOUNDING [0]
 1=yes; 0=no

***19** RANDOMIZE AC LOSS REPORT [0]
 1=10-40 min; 0=normal report (about 2 min. after AC loss).

***20** VIP MODULE PHONE CODE
 Enter 01 - 09 for the first digit; enter [00], [11]
 11 for "*" or 12 for "#" for the second digit.
 Must be set to "0" for UL installations.

***21** PREVENT FIRE TIMEOUT [0]
 1=No timeout; 0=Timeout.

***22** KEYPAD PANIC ENABLES [001]
 1=enable; 0=disable 995 996 999

***23** MULTIPLE ALARMS [1]
 1=yes; 0=no

***24** IGNORE EXPANSION ZONE TAMPER [0]
 1=Ignore; 0=Enable tamper for RF and RPMs.
 Must be "0" for UL installations if using these devices.

***25** BURG.TRIGGER FOR RESPONSE TYPE 8 [1]
 1=enable; 0=disable

***26** INTELLIGENT TEST REPORTING [0]
 1=yes (no report sent if any other report was recently sent);
 0=no (send report at programmed interval, field *27)
 Must be 0 for UL installations.

***27** TEST REPORT INTERVAL [0024]
 Enter interval in hours, 0001-9999; 0000=no report;
 Max. 0024 for UL installations.

***28** POWER UP IN PREVIOUS STATE [1]
 1=yes; 0=no; "1" for UL installations.

***29** QUICK ARM [1]
 1=yes; 0=no

***30** TOUCHTONE OR ROTARY DIAL [0]
 1=TouchTone; 0=rotary

***31** PABX ACCESS CODE
 00-09; B-F (11-15)

***32** PRIM. SUBS. ACCT #
 Enter 00-09; B-F (11-15) [15 15 15 15]

***33** PRIMARY PHONE NUMBER

 Enter 0-9 for each digit. Enter #11 for *, #12 for #,
 #13 for 2 second pause

***34** SECONDARY PHONE NUMBER

 Enter 0-9 for each digit. Enter #11 for *, #12 for #,
 #13 for 2 second pause

***35** DOWNLOAD PHONE NO.

 Enter 0-9 for each digit. Enter #11 for *, #12 for #,
 #13 for 2 second pause

***36** DOWNLOAD ID NO.

 Enter 00-09; A-F (10-15) [15 15 15 15 15 15 15]
 Enter 00-09; A-F (10-15) [15 15 15 15 15 15 15]

***37** DOWNLOAD COMMAND ENABLES

 Dir ShtdwnSys ShtdwnNot UsedRmt BypRmt DisarmRmt ArmUpd PgmDwnld Pgm
 See field 1*53 for Callback disable option; [1=enable];
 0=disable. For UL installations, all entries must be "0."

***38** PREVENT ZONE XXX BYPASS [000]
 001-250; 00 if all zones can be bypassed

***39** ENABLE OPEN/CLOSE REPORT FOR INSTALLER CODE [1]
 1=enable; 0=disable

***40** OPEN/CLOSE REPORT FOR KEYSWITCH [0]
 1=enable; 0=disable

***41** NORMALLY CLOSED or EOLR (Zones 2-8) [0]
 1=N.C.loops; 0=EOLR supervision.
 Must be "0" for UL installations.

***42** DIAL TONE PAUSE [0]
 0=5 seconds; 1=11 seconds; 2=30 seconds.
 Must be "0" UL Installations.

***43** DIAL TONE DETECTION [1]
 1=wait for true dial tone; 0=pause, then dial

***44** RING DETECTION COUNT [00]
 01-14; 15=answering machine; 00=no detection.
 Must be "00" for UL Burglary.

***45** PRIMARY FORMAT [1]
 0=Low Speed; 1=Contact ID; 2=ADEMCO High Speed;
 3= ADEMCO Express

***46** LOW SPEED FORMAT (Primary) [0]
 0= ADEMCO Low Speed; 1=Sescoa/Radionics

***47** SECONDARY FORMAT [1]
 0=Low Speed; 1=Contact ID; 2= ADEMCO High Speed;
 3= ADEMCO Express

***48** LOW SPEED FORMAT (Sec.) [0]
 0= ADEMCO Low Speed; 1=Sescoa/Radionics

***49** CHECKSUM VERIFICATION [0] [0]
 1=yes; 0=no Prim Sec

***50** SESCOA/RADIONICS SELECT [0]
 1=Sescoa; 0=Radionics

***51** DUAL REPORTING [0]
 1=yes; 0=no If used with Spilt Reporting "1" option (1*34),
 alarms and alarm restores go to both primary & secondary
 numbers, while all other reports go to secondary only. If used
 with Split Reporting "2" option, alarms and alarm restores go to
 both, open/close and test messages go to secondary only,
 while all other reports go to primary.

***52** STANDARD/EXPANDED REPORT FOR PRIMARY
 [0 0 0 0 0 0]
 Alarm Rstr Byp Trbl O/C LoBat
 0=standard; 1=expanded;
 Note: Expanded overrides 4+2 format.

***53** STANDARD/EXPANDED REPORT FOR SECONDARY
 [0 0 0 0 0 0]
 Alarm Rstr Byp Trbl O/C LoBat
 0=standard; 1=expanded;
 Note: Expanded overrides 4+2 format.

***54** UNATTENDED MODE [1]
 0=No, 1=Yes, if automatic downloads will be allowed

***56** DYNAMIC SIGNALING DELAY [00]
 Select the delay time (00-15) times 15 seconds before sending
 to second destination.

***57** DYNAMIC SIGNALING PRIORITY [0]

***58** LRR CENTRAL STATION #1 CATEGORY ENABLE
 [0 0 0 0 0 0]
 Alarm Trbl Byp O/C Syst Test
 0=disable, 1=enable for reports for primary subs ID of LRR

***59** LRR CENTRAL STATION #2 CATEGORY ENABLE
 [0 0 0 0 0 0]
 Alarm Trbl Byp O/C Syst Test
 0=disable, 1=enable for reports for secondary subs ID of LRR

ZONE TYPE RESTORE ENABLES

***79** FOR ZONE TYPES 1-8

 1 2 3 4 5 6 7 8
 1=enable; [0=disable]

***80** FOR TYPES 9, 10 and 16
 9 10 16
 1=enable; [0=disable]

***83** FIRST TEST REPORT TIME
 [Day 00; hour 12; min 00] Days 01-07 Hours 00-23 Min 00-59; 00 in all boxes = instant (Day 01= Monday)

***84** SWINGER SUPPRESSION [01]
 01-15 alarms
 Must be "00" (disabled) for UL.

***85** ENABLE DIALER REPORTS FOR PANICS & DURESS
 1=enable; [0=disable]
 995 996 999 Duress

***87** ENTRY WARNING [1]
 1=continuous; 0=3 beeps

***88** BURG. ALARM COMM. DELAY [1]
 1=30 seconds; 0=no delay
 Must be "0" for UL installations. SIA Guidelines: Must be "1".

***89** RESTORE REPORT TIMING [0]
 0=Instant; 1=After bell timeout if zone is restored; 2=when
 system is disarmed. Must be "0" for UL installations.

***90** SEC. SUBS. ACCT #

Enter 00-09; B-F (11-15) [15 15 15 15]

- 1*07** CHECK OR TRBL DISPLAY [0]
1=display TRBL; 0=display CHECK
- 1*10** FIRST TO ALARM DISPLAY LOCK [0]
0=scroll all alarms; 1=lock display of first fire alarm.
- 1*15** CANCEL VERIFY [1]
0=disable, 1=enable alarm output pulse upon kissoff of Cancel report. **Note:** Field 1*52 must be enabled to send a Cancel report to the central station.
- 1*17** LOBBY PARTITION [0]
Enter the "common lobby" partition (1-8)

1*18 AFFECTS LOBBY [0]
Enter 1 if this partition affects the common lobby; enter 0 if it does not.
Must be "0" for UL installations.

1*19 ARMS LOBBY [0]
Enter 1 if arming this partition attempts to arm lobby; enter 0 if it does not.
Must be "0" for UL installations.

1*20 EXIT ERROR LOGIC ENABLE [1]
0=No; 1=Bypass E/E and Interior zones faulted after exit delay.
Must be "0" for UL installations.

1*21 EXIT DELAY RESET [0]
0=No; 1=Resets Exit Delay to programmed value after zone is closed and then faulted prior to end of exit delay.
Must be "0" for UL installations.
SIA Guidelines: Exit Delay must be enabled.

FIELDS 1*22-1*25: Allow four sets of two zones each to be linked so that both must fault within a five minute period to cause an alarm. Default for these fields = [000], [000].

1*22 CROSS-ZONING PAIR ONE

1*23 CROSS-ZONING PAIR TWO

1*24 CROSS-ZONING PAIR THREE

1*25 CROSS-ZONING PAIR FOUR

1*26 PANIC BUTTON OR SPEEDKEY
[00, 00, 00, 00]
A B C D
Enter speedkey macro # (01-32) to use keys A-C for macro. Otherwise enter 00 to use as panic. For D key, enter macro # or 00 to select macro when key is pressed.

MISCELLANEOUS WIRELESS OPTIONS
Fields 1*28 - 1*31 are not applicable for UL installations.

- 1*28** RF TX LOW BATTERY SOUND [0]
1=immediate; 0=when disarmed
- 1*29** RF TX LOW BATTERY REPORTING [0]
1=enable; 0=disable
- 1*30** RF RCVR CHECK-IN INTERVAL [06]
02-15 times 2 hours; 00 disables supervision

1*31 RF XMITTER CHECK-IN INTERVAL [12]
02-15 times 2 hours; 00 disables transmitter supervision

1*33 TOUCHTONE W/ROTARY BACKUP [0]
1=enable; 0=disable

1*34 COMM. SPLIT REPORTING [0]
0=no; 1=alarms and alarm restores primary, others secondary; 2=open/close, test secondary, others primary. See *51 for comments if using with dual reporting.

1*35 ACCESS CONTROL DIALER ENABLES
[0 0 0 0 0 0]
Trace Trbl Byp Not Used Syst Alm
1=enable; 0=disable

1*42 CALL WAITING DEFEAT [0]
1=Yes; 0=No

1*43 PERM. KEYPAD BACKLIGHT [0]
1=enable; 0=disable When disabled, display lights when any key is pressed, and turns off after period of keypad inactivity.

1*44 WIRELESS KEYPAD TAMPER [0]
DETECTION
1=enable; 0=disable.
Must be "0" for UL installations.

1*45 EXIT DELAY SOUNDING [1]
1=enable; 0=disable. Produces quick beeping during exit delay if enabled.
NOTE: See page 32, "SOUND OPTION", prompt for disabling the entry/exit beeps on individual keypads.

1*46 AUXILIARY OUTPUT MODE [0]
Enter 0 for ground start output.
Enter 1 for smoke detector reset.
Enter 2 for keypad-like sounding. This option applies only to the VISTA-128BP and to the partition enabled in field *15.
Enter 3 if AAV module is being used.
NOTE: Only one of the above options may be active within the system.

1*47 CHIME ON EXTERNAL SIREN [0]
1=enable; 0=disable

1*48 WIRELESS KEYPAD ASSIGNMENT [0]
0=disable; enter partition in which RF keypad used, 1-8.
Must be "0" for UL installations.

1*49 SUPPRESS TX SUPERVISION SOUND [1]
1=disable; 0=enable.
Must be "0" for UL installations.

1*52 SEND CANCEL IF ALARM + OFF [1]
1=no restriction; 0=within bell timeout period only
SIA Guidelines: Must be enabled "1".

1*53 DOWNLOAD CALLBACK [0]
1=callback not required; 0=callback required.
Must be "0" for UL installations.

1*55 EUROPEAN DATE FORMAT [0]
0=disable (mm/dd/yy); 1=enable (dd/mm/yy).

1*56 AC 50/60 Hz CLOCK SPEED [0]
1=50 Hz; 0=60 Hz.

- 1*57** 5800 RF BUTTON GLOBAL ARM [0]
1=enable; 0=disable
- 1*58** 5800 RF BUTTON FORCE ARM [0]
Enter "1" to enable. If a zone is faulted after pressing button, keypad will beep once. Pressing the button again within 4 sec. bypasses the zone. Enter "0" to disable. Must be "0" for UL installations.
- 1*60** ZONE 5 AUDIO ALARM VERIFICATION [0]
Enter 1 If 2-way audio (AAV) is being used; Enter 0 if it is not. Must be "0" for UL installations.
- 1*69** PRINTER TYPE [0]
Enter 0 if you are using a parallel printer connected to the VA8201 Alpha Pager Module. Enter 1 if you are using a serial printer.
- 1*70** EVENT LOG TYPES [1 0 0 0 1]
Alarm Chk Byp O/C Syst
1=enable; 0=disable
- 1*71** 12/24 HOUR TIME STAMP FORMAT [0]
0=12 hour; 1=24 hour
- 1*72** EVENT LOG PRINTER ON-LINE [0]
0=disable; 1=enable
- 1*73** PRINTER BAUD RATE [0]
1=300; 0=1200
Must be 1200 if using pager interface.
- 1*74** RELAY TIMEOUT XXX MINUTES [000]
Enter the relay timeout, **0-127** in multiples of 2 minutes, desired for #80 Menu Mode time-driven event relay command numbers "04/09" and #93 Menu Mode Output Programming output command "56."
- 1*75** RELAY TIMEOUT YYY SECONDS [000]
Enter the relay timeout, **0-127** seconds, desired for #80 Menu Mode time driven event relay command numbers "05/10" and #93 Menu Mode Output Programming command "57."
- 1*76** ACCESS CONTROL RELAY [00]
Relay will be pulsed for 2 seconds whenever code + [0] is pressed. Enter 00-96; 00=none. Must be "00" for UL.

3rd Page Programming Fields (press *94)

- 2*00** NUMBER OF PARTITIONS [1]
Enter 1-8
- 2*01** DAYLIGHT SAVING TIME [04, 10]
START/END MONTH Start End
00-12; if no daylight saving time, enter 00,00
- 2*02** DAYLIGHT SAVING TIME [1, 5]
START/END WEEKEND Start | End
Enter 1-7. 1=first; 2=second; 3=third; 4=fourth; 5=last; 6=next to last; 7=3rd from last [1,5]
- 2*05** AUTO-ARM DELAY [15]
Enter the time between the end of the arming window and the start of auto-arming warning period, in values of 1-14

- times 4 minutes 00=instant; [15=no auto arm at all]. When this delay expires, the Auto-Arm Warning Period begins.
- 2*06** AUTO-ARM WARNING PERIOD [15]
This is the time during which the user is warned to exit the premises prior to the auto-arming of the system (beeps every 15 seconds; "ALERT" displayed). Enter 01-15 minutes. 00=instant at end of arming delay.
- 2*07** AUTO-DISARM DELAY [15]
This is the time between the end of the disarming window and the start of auto-disarming. Enter 01-14 times 4 minutes; 00=instant at end of window; 15=no auto-disarm.
- 2*08** ENABLE FORCE ARM FOR AUTO-ARM [0]
0=disable; 1=enable
- 2*09** OPEN/CLOSE REPORTS BY EXCEPTION [0]
1=enable; 0=disable
If enabled, only openings and closings occurring outside the scheduled opening/closing windows will trigger dialer reports. Opening reports will also be suppressed during the closing window, in order to prevent false reports when the user arms the system and then reenters the premises to retrieve a forgotten item.
- 2*10** ALLOW DISARMING ONLY DURING [0]
ARMING/DISARMING WINDOWS
0=disable; 1=enable
See system-wide field 2*11 if enabling field 2*10. This feature adds high security to the installation.
- 2*11** ALLOW DISARM OUTSIDE WINDOW [0]
IF ALARM OCCURS
Used only if field 2*10 (partition-specific field) is set to "1." If this field is enabled ("1") the system can be disarmed outside the disarm window if an alarm has occurred. If "0," disarming can only be done during the disarm window. If field 2*10 is set to "0" for a partition, this field has no effect for that partition.
- 2*18** ENABLE GOTO FOR THIS PARTITION [0]
1=Allow log-on from other partitions; 0=disable
- 2*19** USE PARTITION DESCRIPTORS [0]
0=disable; 1=enable
- 2*20** ENABLE J7 TRIGGERS FOR PARTITION [1]
0=disable for displayed partition; 1=enable for displayed partition
- 2*21** ENABLE SUPERVISION PULSES FOR LRR TRIGGER OUTPUTS [000]
Used for supervised connection to 7920SE. F B P
Enter 0 to disable or 1 to enable the listed outputs. F= Fire; B= Burglary; P= Silent Panic/Duress. Must be 1 for UL. Installations.
- 2*22** DISPLAY FIRE ALARMS OF [0]
OTHER PARTITIONS
0=No; 1=Yes.
- 2*23** DISPLAY BURG & PANIC ALARMS OF [0]
OTHER PARTITIONS
0=No; 1=Yes.
- 2*24** DISPLAY TROUBLES OF OTHER [0]
PARTITIONS
0=No; 1=Yes

2*30 PAGER INSTALLED 1=Yes; 0=No [0]

2*31 DELAY PAGING

1 2 3 4 5 6 7 8
[0=disable]; 1=enable

2*32 TIME TO DELAY PAGING AFTER DIALER
000 – 024 times 10 seconds [000]
If field 2*31 is enabled, enter the time to delay before the pager sends the message.

2*33 PAGER 1 PHONE NUMBER

Enter 0-9 for each digit. Enter #11 for *, #12 for #, #13 for 2 second pause

2*34 PAGER 1 ID NUMBER

Enter the pager 1 ID number. Up to 10 digits. Press * after the last digit if less than 10 is required.

2*35 PAGER 1 FORMAT [0]
0= Numeric; 1=ID; 2=Alphanumeric

2*36 PAGER 1 DELAY 1 [000]
Enter the delay time 000-060 seconds. The delay occurs between the phone number and the pager ID.
NOTE: Program only if using numeric format.

2*37 PAGER 1 DELAY 2 [000]
Enter the delay time 000-060 seconds. The delay occurs between the pager ID and the event information.
NOTE: Program only if using numeric format.

2*38 PAGER 1 PARTITION ENABLE

1 2 3 4 5 6 7 8
1=enable; [0=disable]

2*39 PAGER 1 TRIGGER EVENT ENABLES

Alarm Trbl Byp O/C Syst
1=enable; [0=disable]

2*40 PAGER 2 PHONE NUMBER

Enter 0-9 for each digit. Enter #11 for *, #12 for #, #13 for 2-second pause

2*41 PAGER 2 ID NUMBER

Enter the pager 2 ID number. Up to 10 digits. Press * after the last digit if less than 10 is required.

2*42 PAGER 2 FORMAT [0]
0= Numeric; 1=ID; 2=Alphanumeric

2*43 PAGER 2 DELAY 1 [000]
Enter the delay time 000-060 seconds. The delay occurs between the phone number and the pager ID.

NOTE: Program only if using numeric format.

2*44 PAGER 2 DELAY 2 [000]
Enter the delay time 000-060 seconds. The delay occurs between the pager ID and the event information.
NOTE: Program only if using numeric format.

2*45 PAGER 2 PARTITION ENABLE

1 2 3 4 5 6 7 8
1=enable; [0=disable]

2*46 PAGER 2 TRIGGER EVENT ENABLES

Alarm Trbl Byp O/C Syst
1=enable; [0=disable]

2*47 PAGER 3 PHONE NUMBER

Enter 0-9 for each digit. Enter #11 for *, #12 for #, #13 for 2-second pause

2*48 PAGER 3 ID NUMBER

Enter the pager 3 ID number. Up to 10 digits. Press * after the last digit if less than 10 is required.

2*49 PAGER 3 FORMAT [0]
0= Numeric; 1=ID; 2=Alphanumeric

2*50 PAGER 3 DELAY 1 [000]
Enter the delay time 000-060 seconds. The delay occurs between the phone number and the pager ID.
NOTE: Program only if using numeric format.

2*51 PAGER 3 DELAY 2 [000]
Enter the delay time 000-060 seconds. The delay occurs between the pager ID and the event information.
NOTE: Program only if using numeric format.

2*52 PAGER 3 PARTITION ENABLE

1 2 3 4 5 6 7 8
1=enable; [0=disable]

2*53 PAGER 3 TRIGGER EVENT ENABLES

Alarm Trbl Byp O/C Syst
1=enable; [0=disable]

2*54 PAGER 4 PHONE NUMBER

Enter 0-9 for each digit. Enter #11 for *, #12 for #, #13 for 2-second pause

2*55 PAGER 4 ID NUMBER

Enter the pager 4 ID number. Up to 10 digits. Press * after the last digit if less than 10 is required.

2*56 PAGER 4 FORMAT [0]
0= Numeric; 1=ID; 2=Alphanumeric

Enter the pager 6 ID number. Up to 10 digits. Press * after the last digit if less than 10 is required.

2*57 PAGER 4 DELAY 1 [000]

Enter the delay time 000-060 seconds. The delay occurs between the phone number and the pager ID.
NOTE: Program only if using numeric format.

2*58 PAGER 4 DELAY 2 [000]

Enter the delay time 000-060 seconds. The delay occurs between the pager ID and the event information.
NOTE: Program only if using numeric format.

2*59 PAGER 4 PARTITION ENABLE

1 2 3 4 5 6 7 8

1=enable; [0=disable]

2*60 PAGER 4 TRIGGER EVENT ENABLES

Alarm Trbl Byp O/C Syst
1=enable; [0=disable]

2*61 PAGER 5 PHONE NUMBER

Enter 0-9 for each digit. Enter #11 for *, #12 for #, #13 for 2-second pause

2*62 PAGER 5 ID NUMBER

Enter the pager 5 ID number. Up to 10 digits. Press * after the last digit if less than 10 is required.

2*63 PAGER 5 FORMAT [0]

0= Numeric; 1=ID; 2=Alphanumeric

2*64 PAGER 5 DELAY 1 [000]

Enter the delay time 000-060 seconds. The delay occurs between the phone number and the pager ID.
NOTE: Program only if using numeric format.

2*65 PAGER 5 DELAY 2 [000]

Enter the delay time 000-060 seconds. The delay occurs between the pager ID and the event information.
NOTE: Program only if using numeric format.

2*66 PAGER 5 PARTITION ENABLE

1 2 3 4 5 6 7 8

1=enable; [0=disable]

2*67 PAGER 5 TRIGGER EVENT ENABLES

Alarm Trbl Byp O/C Syst
1=enable; [0=disable]

2*68 PAGER 6 PHONE NUMBER

Enter 0-9 for each digit. Enter #11 for *, #12 for #, #13 for 2-second pause

2*69 PAGER 6 ID NUMBER

2*70 PAGER 6 FORMAT [0]

0= Numeric; 1=ID; 2=Alphanumeric

2*71 PAGER 6 DELAY 1 [000]

Enter the delay time 000-060 seconds. The delay occurs between the phone number and the pager ID.
NOTE: Program only if using numeric format.

2*72 PAGER 6 DELAY 2 [000]

Enter the delay time 000-060 seconds. The delay occurs between the pager ID and the event information.
NOTE: Program only if using numeric format.

2*73 PAGER 6 PARTITION ENABLE

1 2 3 4 5 6 7 8

1=enable; [0=disable]

2*74 PAGER 6 TRIGGER EVENT ENABLES

Alarm Trbl Byp O/C Syst
1=enable; [0=disable]

2*75 PAGER 7 PHONE NUMBER

Enter 0-9 for each digit. Enter #11 for *, #12 for #, #13 for 2-second pause

2*76 PAGER 7 ID NUMBER

Enter the pager 7 ID number. Up to 10 digits. Press * after the last digit if less than 10 is required.

2*77 PAGER 7 FORMAT [0]

0= Numeric; 1=ID; 2=Alphanumeric

2*78 PAGER 7 DELAY 1 [000]

Enter the delay time 000-060 seconds. The delay occurs between the phone number and the pager ID.
NOTE: Program only if using numeric format.

2*79 PAGER 7 DELAY 2 [000]

Enter the delay time 000-060 seconds. The delay occurs between the pager ID and the event information.
NOTE: Program only if using numeric format.

2*80 PAGER 7 PARTITION ENABLE

1 2 3 4 5 6 7 8

1=enable; [0=disable]

2*81 PAGER 7 TRIGGER EVENT ENABLES

Alarm Trbl Byp O/C Syst
1=enable; [0=disable]

2*82 PAGER 8 PHONE NUMBER

Enter 0-9 for each digit. Enter #11 for *, #12 for #,

2*83 PAGER 8 ID NUMBER

Enter the pager 8 ID number. Up to 10 digits. Press * after the last digit if less than 10 is required.

2*84 PAGER 8 FORMAT

[0]

0= Numeric; 1=ID; 2=Alphanumeric

2*85 PAGER 8 DELAY 1

[000] |

Enter the delay time 000-060 seconds. The delay occurs between the phone number and the pager ID.

NOTE: Program only if using numeric format.

2*86 PAGER 8 DELAY 2

[000] |

Enter the delay time 000-060 seconds. The delay occurs between the pager ID and the event information.

NOTE: Program only if using numeric format.

2*87 PAGER 8 PARTITION ENABLE

1 2 3 4 5 6 7 8

1=enable; [0]=disable]

2*88 PAGER 8 TRIGGER EVENT ENABLES

Alarm Trbl Byp O/C Syst

1=enable; [0]=disable]

SUMMARY OF PROGRAMMING COMMANDS

- **To enter program mode**, enter installer code + [8] + [0] + [0] + [0]
- **To set standard defaults**, press *97
- **To change to next page of program fields**, press *94
- **To return to previous set of fields**, press *99
- **To erase account and phone number field entries**, press [*] + field number + [*]
- **To assign zone descriptors**, press #93 + follow menu prompts
- **To add custom words**, press #93 + follow menu prompts
- **To enter Installer's Message**, press #93 + follow menu prompts
- **To exit program mode**, enter *99 OR *98: *99 allows re-access to programming mode by installer code. *98 prevents re-access to programming mode by installer code.

Partition-Specific Fields

(Duplicate this page for each partition in the installation.)

To program these fields,

1. Press *91 to select a partition.
2. Enter a partition-specific field number (ex. *09).
3. Make the required entry.
4. Repeat steps 1-3 for each partition in the system.

PARTITION # _____ PROGRAM FIELDS

1st Page Fields

- *06** QUICK EXIT [1]
 1=enable; 0=disable
 Must be 0 for UL installations.
- *09** ENTRY DELAY #1 [02]
 00, 02-15 times 15 seconds.
 Maximum 03 for UL Listed installations.
 SIA Guidelines: The entry delay time and Burg Alarm Comm Delay (field *88) combined cannot exceed 1 minute.
- *10** EXIT DELAY #1 [04]
 00, 03-15 times 15 seconds.
 Maximum 04 for UL Listed installations.
 SIA Guidelines: Minimum 45 seconds "03".
- *11** ENTRY DELAY #2 [02]
 00, 02-15 times 15 seconds.
 Maximum 03 for UL installations.
 SIA Guidelines: The entry delay time and Burg Alarm Comm Delay (field *88) combined cannot exceed 1 minute.
- *12** EXIT DELAY #2 [08]
 00, 03-15 times 15 seconds.
 Maximum 04 for UL installations.
 SIA Guidelines: Minimum 45 seconds "03".
- *13** ALARM SOUNDER DURATION [04]
 01-15 times 2 minutes.
 Must be minimum 16 minutes for UL installations.
 SIA Guidelines: Must be minimum 6 minutes.
- *16** CONFIRMATION OF ARMING DING [0]
 1=enable; 0=disable.
 Must be "1" for UL installations.
- *22** KEYPAD PANIC ENABLES [001]
 1=enable; 0=disable
 995 996 999
- *23** MULTIPLE ALARMS [1]
 1=yes; 0=no.
 Must be 1 for UL installations.
- *29** QUICK ARM [1]
 1=yes; 0=no
- *32** PRIM. SUBS. ACCT #
 Enter 00-09; B-F (11-15) [15 15 15 15]
- *38** PREVENT ZONE XXX BYPASS [000]
 001-250; 000 if all zones can be bypassed
- *39** ENABLE OPEN/CLOSE REPORT [1]
 FOR INSTALLER CODE
 1=enable; 0=disable
- *84** SWINGER SUPPRESSION [01]
 01-15 alarms;
 Must be "00" (disabled) for UL installations..
- *85** ENABLE DIALER REPORTS FOR PANICS & DURESS
 1=enable; [0=disable]
 995 996 999 Duress
- *87** ENTRY WARNING [1]
 1=continuous; 0=3 beeps
- *88** BURG. ALARM COMM. DELAY [1]
 1=30 seconds; 0=no delay.
 Must be "0" for UL installations. SIA Guidelines: Must be "1".
- *90** SEC. SUBS. ACCT #
 Enter 00-09; B-F (11-15) [15 15 15 15]

2nd Page Fields

- 1*18** AFFECTS LOBBY [0]
 Enter 1 if this partition affects the common lobby; enter 0 if it does not.
- 1*19** ARMS LOBBY [0]
 Enter 1 if arming this partition attempts to arm lobby; enter 0 if it does not
- 1*26** PANIC BUTTON OR SPEEDKEY

 [00, 00, 00, 00] **A B C D**
 Enter speedkey macro # (01-35) to use keys A-C for macro. Otherwise enter 00 to use as panic. For D key, enter macro # or 00 to select macro when key is pressed.
- 1*43** PERM. KEYPAD BACKLIGHT [0]
 1=enable; 0=disable When disabled, display lights when any key is pressed, and turns off after period of keypad inactivity.
- 1*45** EXIT DELAY SOUNDING [1]
 1=enable; 0=disable. Produces quick beeping during exit delay if enabled. **NOTE:** See page 32, "SOUND OPTION", prompt for disabling the entry/exit beeps on individual keypads.
- 1*47** CHIME ON BELL 1 [0]
 1=enable; 0=disable

1*52 SEND CANCEL IF ALARM + OFF [1]
1=no restriction; 0=within Bell Timeout period only
SIA Guidelines: Must be enabled "1".

1*76 ACCESS CONTROL RELAY FOR PART.[00] |
Relay will be pulsed for 2 seconds whenever code + [0] is pressed. Enter 00-96; 00=none.
Must be "00" for UL installations.

3rd Page Fields

2*05 AUTO-ARM DELAY [15] |
Enter the time between the end of the arming window and the start of auto-arming warning period, in values of 1-14 times 4 minutes 00=instant; [15=no auto arm at all]. When this delay expires, the Auto-Arm Warning Period begins.

2*06 AUTO-ARM WARNING PERIOD [15] |
This is the time during which the user is warned to exit the premises prior to the auto-arming of the system (beeps every 15 seconds; "ALERT" displayed). Enter 01-15 minutes. 00=instant at end of arming delay .

2*07 AUTO-DISARM DELAY [15] |
This is the time between the end of the disarming window and the start of auto-disarming. Enter 01-14 times 4 minutes; 00=instant at end of window; 15=no auto-disarm

2*08 ENABLE FORCE ARM FOR AUTO-ARM [0]
0=disable; 1=enable

2*09 OPEN/CLOSE REPORTS BY EXCEPTION [0]
1=enable; 0=disable If enabled, only openings and closings occurring outside the scheduled opening/closing windows will trigger dialer reports. Opening reports will also be suppressed during the closing window, in order to prevent false reports when the user arms the system and then re-enters the premises to retrieve a forgotten item.

2*10 ALLOW DISARMING ONLY DURING [0]
ARMING/DISARMING WINDOWS
See system-wide field 2*11 if enabling field 2*10. This feature adds high security to the installation.

0=disable; 1=enable

2*18 ENABLE GOTO FOR THIS PARTITION [0]
1=Allow log-on from other partitions; 0=disable

2*20 ENABLE J7 TRIGGERS BY PARTITION [1]
0=disable for displayed partition; 1=enable for displayed partition

2*22 DISPLAY FIRE ALARMS OF [0]
OTHER PARTITIONS
0=No; 1=Yes

2*23 DISPLAY BURG/PANIC ALARMS OF [0]
OTHER PARTITIONS
10=No; 1=Yes

2*24 DISPLAY TROUBLES OF OTHER [0]
PARTITIONS
0=No; 1=Yes

SUMMARY OF PROGRAMMING COMMANDS

- **To enter program mode**, enter installer code + [8] + [0] + [0] + [0]
- **To set standard defaults**, press *97
- **To change to next page of program fields**, press *94
- **To return to previous set of fields**, press *99
- **To erase account and phone number field entries**, press [*] + field number + [*]
- **To assign zone descriptors**, press #93 + follow menu prompts
- **To add custom words**, press #93 + follow menu prompts
- **To enter Installer's Message**, press #93 + follow menu prompts
- **To exit program mode**, enter *99 OR *98: *99 allows re-access to programming mode by installer code. *98 prevents re-access to programming mode by installer code.

Programming With #93 Menu Mode

NOTE: The following field should be preset before beginning: 2*00 Number of Partitions. In addition, receivers should be programmed via Device programming.

After programming all system related programming fields in the usual way, press #93 while still in programming mode to display the first choice of the menu driven programming functions. Press 0 (NO) or 1 (YES) in response to the displayed menu selection. Pressing 0 will display the next choice in sequence.

NOTE: All references in this manual for number of zones, number of user codes, number of access cards, and the event log capacity, use the VISTA-250BP's features. See page 2 of this manual for the table listing the differences between the VISTA-128BP and the VISTA-250BP control panels.

UL

For UL installations, verify that the audio alarm verification feature is disabled.

#93 MENU MODE KEY COMMANDS

The following is a list of commands used while in the menu mode.

#93	Enters Menu mode
[*]	Serves as ENTER key. Press to have keypad accept entry.
[#]	Backs up to previous screen.
0	Press to answer NO
1	Press to answer YES
001-009	All data entries are either 2-digit or 3-digit entries.
000	Exits menu mode, back into field programming mode, when entered at the first question for each category.

Menu selections are as follows:

PROMPT	EXPLANATION
<div style="border: 1px solid black; padding: 5px;"> ZONE PROG? 1 = YES 0 = NO 0 </div>	For programming the following: <ul style="list-style-type: none"> • Zone Number • Zone Response Type • Partition Number for Zone • Dialer report code for zone • Input Device Type for zone (whether RF, polling loop, etc.) • Enrolling serial numbers of 5800 Series transmitters & serial polling loop devices into the system. • Zone Attributes (e.g., Arm w/Fault, Silent, etc.)
<div style="border: 1px solid black; padding: 5px;"> EXPERT MODE? 1 = YES 0 = NO 0 </div>	Same as Zone Programming except: <ul style="list-style-type: none"> • Done with a minimum number of keystrokes. • Can program wireless keys using pre-defined templates. <p>NOTE: Some of the zone attributes cannot be programmed in the Expert Mode, only in Zone Programming.</p>
<div style="border: 1px solid black; padding: 5px;"> REPORT CODE PROG? 1 = YES 0 = NO 0 </div>	For programming the following: <ul style="list-style-type: none"> • Alarm report codes for zones • Restore & supervisory codes • All other system report codes
<div style="border: 1px solid black; padding: 5px;"> ALPHA PROG? 1 = YES 0 = NO 0 </div>	For entering alpha descriptors for the following: <ul style="list-style-type: none"> • Zone Descriptors • Installer's Message • Custom Words • Partition Descriptors • Relay Descriptors
<div style="border: 1px solid black; padding: 5px;"> DEVICE PROG? 1 = YES 0 = NO 0 </div>	For defining the following device characteristics for addressable devices, including keypads, RF receivers (5881), output relay modules (4204/4204CF), FSA modules, 4285/4286 VIP Module, ECP Long Range Radio (7820), Panel Link module, and VISTA gateway module: <ul style="list-style-type: none"> • Device Address • Device Type • Keypad Options (incl. partition assignment) • RF House ID • LRR Options (incl. programming radio) • Panel Linking Options

PROMPT	EXPLANATION
OUTPUT PGM? 1 = YES 0 = NO 0	For defining output relay functions.
RLY VOICE DESCR? 1 = YES 0 = NO 0	For entering voice descriptors for relays to be used with the 4285/4286 VIP Module.
CUSTOM INDEX ? 1 = YES 0 = NO 0	For creating custom word substitutes for VIP Module annunciation.
ACCESS POINT PGM 1 = YES 0 = NO 0	For defining the parameters for each of the VistaKey access points, including which group(s) have access through an access point (door). See the <i>VistaKey-SK Installation and Setup Guide</i> for the detailed programming instructions.
ACCESS GRP PGM 1 = YES 0 = NO 0	For defining the capabilities (privileges) for each group of users. See the <i>VistaKey-SK Installation and Setup Guide</i> for the detailed programming instructions.
EVENT/ACTION PGM 1 = YES 0 = NO 0	For defining events and time windows for an access group. See the <i>VistaKey-SK Installation and Setup Guide</i> for the detailed programming instructions.
SCHEDULED CHK-IN 1 = YES 0 = NO 0	For defining the schedule for the system to automatically call the downloader.

Zone Programming



If using 5800 Series transmitters, do not the install batteries until you are ready to enroll them. After enrolling the transmitter, the battery need not be removed. This is to prevent enrolling the wrong serial number.

PROMPT	EXPLANATION
ZONE PROG? 1 = YES 0 = NO 0	Press 1 to enter ZONE PROGRAMMING mode. The following screens appear. Press [*] to display the next screen. Press # to display a previous screen.
SET TO CONFIRM? 1 = YES 0 = NO 0	This prompt appears once upon entering Zone Programming Mode. If "Yes," Confirmation prompts will be displayed after the device's Serial and Loop numbers have been entered later.
ENTER ZONE NO. 000 = QUIT 010 Zone 010 entered ↑	Enter the 3-digit zone number to be programmed, as follows: Protection Zones = 001–250 Relay Zones = 601–632 ECP Device Supervisory Zones = 800–830 System Supervisory Zones = 970 (bell supervision), 988, 990 (RF receiver), 992 (duress), 997 (polling loop) Keypad Panic Zones = 995, 996, 999 NOTE: When supervising the bell output (zone 970), only one device can be connected to the alarm output (terminals 4 and 5) for UL and Fire installations. Press [*] to continue.
010 ZT P RC In L 00 1 10 00 1	This display appears, showing a summary of the zone's current programming. ZT = Zone Type, P = Partition, RC = Report Code, In = the input type of device, and L = the device's loop number to which the sensor is connected. Some devices can support more than one zone by means of individual loops (for example, 5801, 5804, 5816, 5817, etc.). If the zone is not programmed, the display appears as shown here. If you are checking a zone's programming, and it is programmed satisfactorily, press [#] to back up one step and enter another zone number, if desired. Press [*] to continue.

PROMPT	EXPLANATION																						
<p>010 ZONE TYPE PERIMETER 03</p> <p>Zone number 010 and Zone Type 03 entry shown † These are special zone types used with 5800 Series Wireless Pushbutton Units that result in arming the system in the STAY or AWAY mode, or disarming the system, depending on the selection made.</p>	<p>Each zone must be assigned a zone type, which defines the way in which the system responds to faults in that zone. Refer to the <i>Zone Type Definitions</i> section in the <i>VISTA-128BP/VISTA-250BP Installation and Setup Guide</i> for detailed definitions of each zone type. Enter the zone type desired (or change it, if necessary). Available zone types are listed below.</p> <table border="0"> <tr> <td>00 = Assign for Unused Zones</td> <td>14 = Panel Link Supervision</td> </tr> <tr> <td>01 = Entry/Exit #1, Burglary</td> <td>16 = Fire With Verification</td> </tr> <tr> <td>02 = Entry/Exit #2, Burglary</td> <td>20 = Arm-STAY†</td> </tr> <tr> <td>03 = Perimeter, Burglary</td> <td>21 = Arm AWAY†</td> </tr> <tr> <td>04 = Interior Follower, Burglary</td> <td>22 = Disarm†</td> </tr> <tr> <td>05 = Trouble Day/Alarm Night</td> <td>23 = No Alarm Response (e.g., relay activation)</td> </tr> <tr> <td>06 = 24 Hr. Silent Alarm</td> <td>27 = Access Point</td> </tr> <tr> <td>07 = 24 Hr. Audible Alarm</td> <td>28 = MLB Supervision (if VGM installed)</td> </tr> <tr> <td>08 = 24 Hr. Auxiliary</td> <td>29 = Momentary Exit (used with VistaKey module)</td> </tr> <tr> <td>09 = Fire Without Verification</td> <td></td> </tr> <tr> <td>10 = Interior Delay, Burglary</td> <td></td> </tr> </table> <p>Press [*] to continue.</p>	00 = Assign for Unused Zones	14 = Panel Link Supervision	01 = Entry/Exit #1, Burglary	16 = Fire With Verification	02 = Entry/Exit #2, Burglary	20 = Arm-STAY†	03 = Perimeter, Burglary	21 = Arm AWAY†	04 = Interior Follower, Burglary	22 = Disarm†	05 = Trouble Day/Alarm Night	23 = No Alarm Response (e.g., relay activation)	06 = 24 Hr. Silent Alarm	27 = Access Point	07 = 24 Hr. Audible Alarm	28 = MLB Supervision (if VGM installed)	08 = 24 Hr. Auxiliary	29 = Momentary Exit (used with VistaKey module)	09 = Fire Without Verification		10 = Interior Delay, Burglary	
00 = Assign for Unused Zones	14 = Panel Link Supervision																						
01 = Entry/Exit #1, Burglary	16 = Fire With Verification																						
02 = Entry/Exit #2, Burglary	20 = Arm-STAY†																						
03 = Perimeter, Burglary	21 = Arm AWAY†																						
04 = Interior Follower, Burglary	22 = Disarm†																						
05 = Trouble Day/Alarm Night	23 = No Alarm Response (e.g., relay activation)																						
06 = 24 Hr. Silent Alarm	27 = Access Point																						
07 = 24 Hr. Audible Alarm	28 = MLB Supervision (if VGM installed)																						
08 = 24 Hr. Auxiliary	29 = Momentary Exit (used with VistaKey module)																						
09 = Fire Without Verification																							
10 = Interior Delay, Burglary																							
<p>010 Arm w/ Fault? 1 = YES 0 = NO 0</p>	<p>If you selected response type 1, 2, 4, or 10, this prompt appears. Enter 1 to enable arming of the partition with this zone faulted. The zone must be restored (see Force Arming, the next prompt) before the exit delay expires otherwise the system starts the entry delay and must be disarmed, or an alarm occurs.</p>																						
<p>010 Force Arming? 1 = YES 0 = NO 0</p>	<p>If you entered 1 (YES) at the previous prompt, this prompt appears. Enter 1 to enable the system to automatically bypass the zone if it is faulted at the end of the exit delay.</p> <p>If you enter 0 to disable and the zone is faulted at the end of exit delay, the system either performs the exit error logic, if field 1*20 is enabled, or an alarm occurs.</p> <p>NOTE: Force Arming cannot be enabled for UL installations.</p>																						
<p>010 Vent zone ? 1 = YES 0 = NO 0</p>	<p>If you selected response type 3, this prompt appears. Enter 1 to enable the arming of the partition with this zone faulted (force arm). The zone is automatically bypassed.</p> <p>Note: The zone may be unbypassed simply by restoring the zone (e. g.,closing the window), if the Vent Re-arm option (next prompt) for the zone is enabled.</p> <p>Enter 0 to disable.</p> <p>Press [*] to continue.</p>																						
<p>010 Vent Re-arm ? 1 = YES 0 = NO 1</p>	<p>If you entered 1 (YES) at the previous prompt, this prompt will appear. Enter 1 to enable the system to automatically unbypass the zone when it is restored (e.g., by closing the window).</p> <p>Enter 0 to disable. The zone is bypassed for the duration of the armed period regardless of the zone status.</p> <p>Press [*] to continue.</p>																						
<p>010 STAY MODE None 0</p>	<p>If you selected response type 1, 2, 3, 4, 5, or 10, this prompt will appear. Enter the STAY mode for this zone (0-2).</p> <p>0 = None. The zone is not bypassed when the partition is armed STAY.</p> <p>1 = Stay 1. The zone is automatically bypassed when the user enters [User Code] + [3] (STAY) + [1].</p> <p>2 = Stay 2. The zone is automatically bypassed when the user enters [User Code] + [3] (STAY) + [2].</p> <p>Notes:</p> <p>0 (None) cannot be selected for response types 4 and 10.</p> <p>Response types 4 and 10 are defaulted for STAY mode 1.</p> <p>If the user enters [User Code] + [3] (STAY) + [3], all zones assigned to Stay mode 1 and 2 in the partition are automatically bypassed.</p> <p>If none of the zones in the partition are assigned to Stay mode 2, then when the user enters [User Code] + [3] (STAY), all zones assigned to Stay mode 1 are automatically bypassed.</p> <p>Press [*] to continue.</p>																						
<p>010 Auto-stay ? 1 = YES 0 = NO 0</p>	<p>If you selected response type 1, 2, 3, 4, 5, or 10, this prompt will appear. Enter 1 to enable. The zone is automatically bypassed if none of the entry/exit zones are opened during the exit delay time (no one exits the premises).</p> <p>Enter 0 to disable.</p> <p>Notes: All zones enabled for auto-stay except types 3 and 5 have exit delay time when the partition is armed. If auto-stay is enabled, make sure at least one zone is programmed for entry/exit in the same partition, otherwise this zone will be automatically bypassed every time the partition is armed.</p> <p>Press [*] to continue.</p>																						

PROMPT	EXPLANATION
010 Silent ? 1 = YES 0 = NO 1	<p>If you selected response type 1, 2, 3, 4, 5, or 10, this prompt will appear. Enter 1 to enable. The zone follows all the selected response type's characteristics, except in the alarm condition, the alarm output and the keypad sounder do not sound and the keypad does not display the alarm condition.</p> <p>Enter 0 to disable. Press [*] to continue.</p>
010 Bypass Group 01-15 01	<p>If you selected response type 1, 2, 3, 4, 5, or 10, this prompt will appear. Enter the bypass group for the zone (01–15). This enables the user to bypass a group of zones by entering [User Code] + [6] (Bypass) + [*] + [Group No.] (01-15).</p> <p>Enter 00 for None. Press [*] to continue.</p>
010 ACCESS POINT (00-31) 01	<p>If response type 27, or 29 was selected, this prompt will be displayed. Enter the access point to be controlled by the input type (00-31 for type 27; 01-15 for type 29).</p> <p>Note: If you are using the VistaKey module, the access point must match the address that was set in the module. Press [*] to continue.</p>
010 ENTRY OR EXIT 0	<p>If response type 27, or 29 was selected selected, this prompt will be displayed. Enter whether the access point is an entry or exit point.</p> <p>0 = entry; 1 = exit Press [*] to continue.</p>
010 Panel ID# (01-08) 01	<p>If you selected response type 14, this prompt appears. Enter the panel ID#. This ID # must match the ID # programmed in Device Programming. Press [*] to accept entry.</p>
010 Partition 1	<p>Enter the partition number (1–8) you are assigning this zone to. Press [*] to continue.</p>
010 REPORT CODE 1st 03 2nd 12 3C	<p>Enter the report code. The report code consists of 2 hexadecimal digits, each in turn consisting of 2 numerical digits. For example, for a report code of "3C," enter 03 for "3" and 12 for "C." (Refer to the <i>System Communication</i> section in the <i>Installation and Setup Guide</i> for more information about report codes and reporting formats.) Press [*] to continue.</p>
010 INPUT TYPE RF Xmitter 3	<p>Enter the input device type as follows:</p> <ul style="list-style-type: none"> 00 = not used 01 = hardwired 02 = RF motion (RM type) 03 = supervised RF transmitter (RF type) 04 = unsupervised RF transmitter (UR type) 05 = RF button-type transmitter (BR type) 06 = serial number polling loop device (SL type) 07 = DIP switch-type polling loop device 08 = right loop of DIP switch type device 09 = keypad input (code + #73) 10 = PassPoint ACS input 11 = VistaKey Door Status Monitor (DM) 12 = VistaKey Request to Exit (RE) 13 = VistaKey General Purpose (GP) <p>Right loops refer to the use of the right loop on a 4190WH Zone Expander Module and/or 4278 PIR, which allow hardwired devices to be monitored by the polling loop.</p> <p>If you are programming hardwired or DIP switch polling loop devices, the summary display appears after completing this entry.</p> <p>NOTE: Input types 11 (DM), 12 (RE), and 13 (GP) should only be used with VistaKey modules. Press [*] to continue.</p>

PROMPT	EXPLANATION
001 Tamper Option none 0	<p>If you selected input type 1, 6, 7, or 8, this prompt displays. If the zone has a tamper switch wired in the loop in addition to a sensor contact, enter the tamper option.</p> <p>Enter 1 if the tamper switch is normally closed (wired in series) with the EOL resistor.</p> <p>Enter 2 if the tamper switch is normally open (wired in parallel) with the EOL resistor.</p> <p>Enter 0 if a tamper switch is not being used in the loop.</p> <p>NOTE: For zone response types 9 or 16 (Fire), the tamper selection must be "0" none.</p>
010 V-PLEX RELAY? 1 = YES 0 = NO	<p>If you selected input type 6, this prompt displays. Enter 1 if using a 4101SN Relay Module for this zone. Otherwise enter 0.</p> <p>Press [*] to continue.</p>
010 CONS ECP ADDR (00-30) 01	<p>If you selected input type 09, this prompt displays. Enter the ECP address of the keypad that is being used for entry/exit for this access point (00-30).</p> <p>Press [*] to continue.</p>
010 ACS ZONE # (00-31) 01	<p>If you selected input type 10, this prompt displays. Enter the PassPoint ACS zone ID that this VISTA zone maps to (00-31).</p> <p>Press [*] to continue.</p>
010 ACCESS POINT (01-15) 01	<p>If you selected input types 06, or 11 – 13, this prompt displays. Enter the access point (01-15) to be controlled by the input type.</p> <p>Note: For input type 06, the selected address must be 00.</p> <p>Note: If you are using the VistaKey module, the access point must match the address that was set in the module.</p> <p>Press [*] to continue.</p>
010 INPUT S/N: AXXX-XXXX L 1	<p>For Serial Number entry and Loop Number entry, do one of the following:</p> <ol style="list-style-type: none"> Transmit two open and close (or close and open) sequences. For a button-type transmitter, press and release the button, wait approximately 4 seconds, then press and release the button a second time. <p>OR</p> <ol style="list-style-type: none"> Manually enter the 7-digit serial number printed on a label on the transmitter, using the Alpha keypad. Then press the [*] key, the cursor moves to the "L" position. You can edit the loop number, if necessary. When the loop number is acceptable, press [*]. <p>OR</p> <ol style="list-style-type: none"> Press key [C] to copy the last serial number enrolled (used when programming a transmitter with several input loops). <p>Press [*] to accept.</p>
010 INPUT S/N: A022-4064 L 1	<p>The cursor will then move to the Loop column (L) with the previously entered/transmitted serial number displayed.</p> <p>Enter the loop number (refer to 5800 Series Transmitters Loop Designations below).</p> <p>To Delete an Existing Serial Number, enter "0" in the loop number field. The serial number will change to "0"s.</p> <p>If "0" was entered in error, simply re-enter the loop number or press [#], and the serial number will return to the display.</p> <p>Press [*] to accept.</p>
010 INPUT S/N: A022-4064 L 1	<p>The system will then check for a duplicate serial/loop number combination.</p> <p>If a duplicate serial/loop number combination is found, the keypad will emit a single long beep, and display the serial number along with a "?" for the loop number, allowing you to re-enter the correct loop number.</p> <p>If the serial/loop number combination is not a duplicate in the system, a display appears showing the serial number and loop number entry.</p> <p>Press [*] to continue.</p>

5800 Series Transmitters Loop Designations

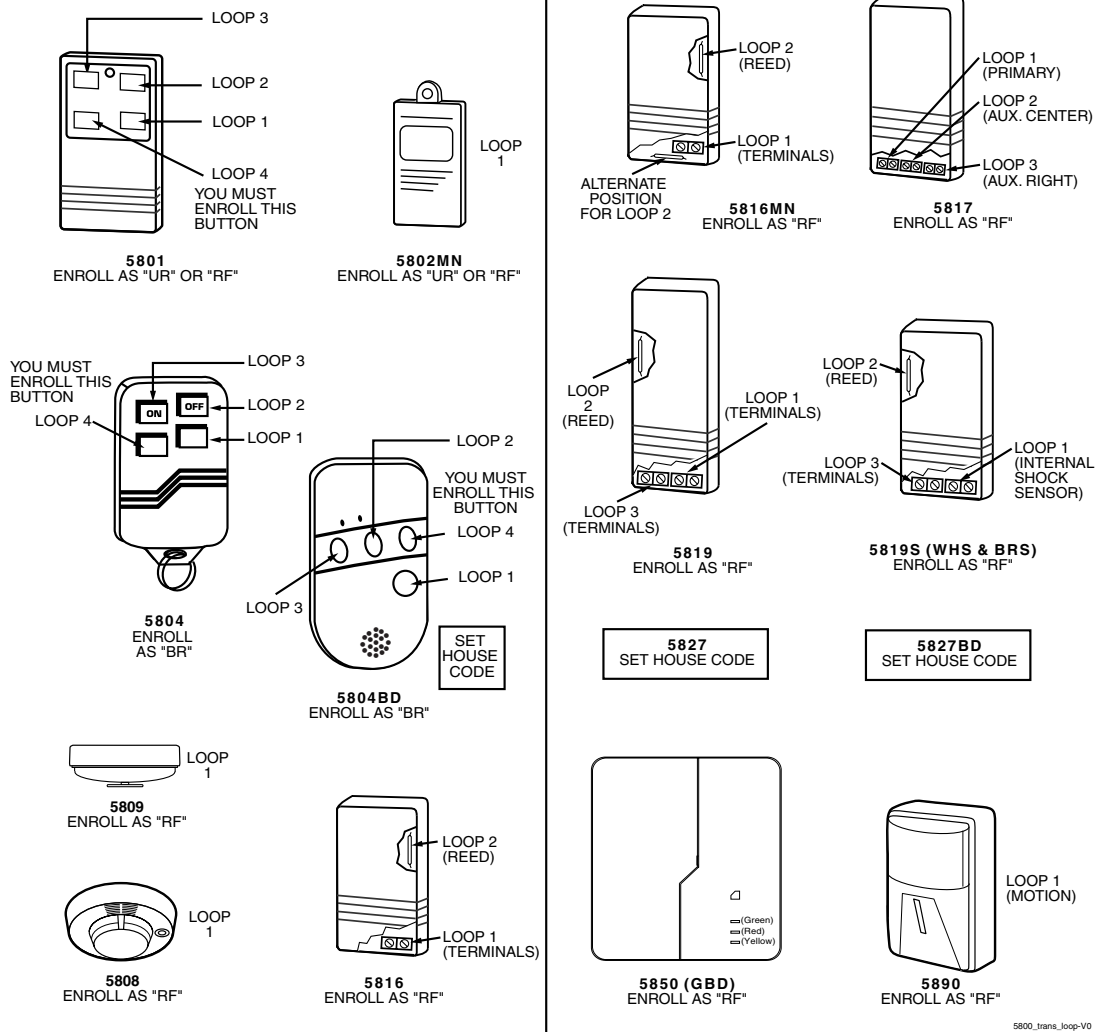

Note: For information on any transmitter not shown above, refer to the instructions accompanying that transmitter for details regarding loop numbers, etc.



The 5802MN, 5802MN2, 5804, 5804BD, 5814, 5816TEMP, 5819, 5819WHS & BRS, 5827BD, and 5850 transmitters are not intended for use in UL installations.

PROMPT	EXPLANATION
<div style="border: 1px solid black; padding: 5px;"> XMIT TO CONFIRM PRESS *TO SKIP </div>	<p>Confirmation Option: This prompt only appears if you answered "Yes" at the first prompt. The system enters a confirmation mode so that the operation of the actual programmed input can be confirmed. Activate the loop input or button that corresponds to this zone. At any time during this step, you may press the [*] key on the keypad to save the serial and loop number combination without confirming.</p>
<div style="border: 1px solid black; padding: 5px;"> Entd A022-4063 1 Rcvd A022-4064 </div>	<p>If the serial number transmitted does not match the serial number entered, a display similar to the one at the left appears. If the loop number does not match, it is also displayed. If so, activate the loop input or button on the transmitter once again. If a match is not obtained (i.e., summary display does not appear), press the [#] key twice and then enter or transmit the correct serial number.</p>
<div style="border: 1px solid black; padding: 5px;"> 010 ZT P RC In L 03 1 3C RF 1s </div>	<p>If the serial number transmitted does match the serial number entered, the system beeps 3 times and a summary display appears, showing that zone's programming. Note that an "s" indicates that a transmitter's serial number has been enrolled. Press [*] to accept the zone information.</p>

PROMPT	EXPLANATION
--------	-------------

ENTER ZONE NO. 000 = QUIT 011	The system now returns to the "ENTER ZONE NO." prompt for the next zone. When all zones have been programmed, enter "000" to quit.
---	---

After you have enrolled each wireless device, remove ONE of the serial number labels from that device and affix it in the appropriate column on the worksheets provided later in this *Programming Guide*; then enter the other information (zone number, zone type, etc.) relevant to that device.



When you have finished programming all zones, test each using the system's Test Mode. Do not use the Transmitter ID Sniffer Mode. The system checks only for transmission of one zone on a particular transmitter, NOT the zones assigned to each additional loop, and also does not verify polling loop type zones.

Expert Mode Zone Programming

Expert mode allows you to program zones using the minimum number of screens and keystrokes.



Expert Mode Zone Programming does not provide the capability to program some of the zone's attributes, such as Arm w/Fault, Vent Zone, STAY mode, Auto-STAY, Bypass Group, etc. If you want to program a zone for any of these attributes, you must use Zone Programming.

Enter the Programming mode with [Installer Code] + 8 0 0 0

Before programming your zones, do the following:

1. Program field 2*00: Number of Partitions.
2. Enable your RF Receiver in *Device Programming* menu mode.

To program your zones, press *93 to display the "ZONE PROG?" prompt. Enter "0" (NO) to each prompt until the "EXPERT MODE?" prompt appears.

PROMPT	EXPLANATION
--------	-------------

EXPERT MODE? 1 = YES 0 = NO 0	Press 1 to enter Expert mode.
--	-------------------------------

SET TO CONFIRM? 0 = NO 1 = YES 0	This prompt appears once upon entering Expert Mode. If you select "Yes," Confirmation prompts will be displayed after the device's Serial and Loop numbers have been entered later.
---	--

Zn ZT P RC In L 001 03 1 10 HW -	A summary display appears, showing zone 1's current programming or default values.
--	--

Zn ZT P RC In L 010 03 1 10 RF 1s	Enter the desired 3-digit zone number and press [*]. Note: If you want to exit the Expert mode, enter "000" + [*]. If an "s" appears after the loop number, it indicates that the transmitter's serial number has been enrolled. Use the [D] key to enter and duplicate wireless keys (see "Entering Wireless Keys" later)
---	--

PROMPT	EXPLANATION
--------	-------------

Zn	ZT	P	RC	In	L
010	03	1	10	RF	-

Enter all zone information except for Loop number, or press “C” to copy the zone information on this screen from the last saved zone (including Loop).

- ZT = Zone Type
- P = Partition
- RC = Report Code
- In = Input Device Type
- L = Loop number to which the sensor is connected.

NOTE: Pressing the [C] copies the zone information from the last saved zone, which includes the input type. Verify this information is correct for this zone.

On this screen:

- Use the [A] key to move to the right.
- Use the [B] key to move to left and to back up to “ZT” field.

Press [*] to accept the existing or newly-entered zone information.

ZN	B	M	V	A	C	E	AD
010	-	-	1	0	1	1	01

Enter the remainder of the zone’s information, or press the [C] key to copy the zone attributes on this screen from the last saved zone.

- B = Not Applicable
- M = Not Applicable
- V = V-plex Relay? (only used if “In” = 6)
- AC = Access Point (only used if ZT = 27, 29 or In = 6, 11, 12, 13)
- E = Entry or Exit? (only used if ZT = 27)
- AD = Address (only used if “In” = 9 or 10)
 - If “In” = 9, enter the Device Address
 - If “In” = 10, enter the PassPoint Zone Number

NOTE: Pressing the [C] copies the zone attributes from the last saved zone. Verify the attributes for this zone are correct.

On this screen:

- Use the [A] key to move to the right.
- Use the [B] key to move to left and to back up to “V” field.

Press [*] to accept existing information.

010	INPUT S/N:	L
	A XXX-XXXX	-

If you entered RM, RF, BR, UR or SL for the Input Type, this screen displays. Otherwise the summary screen for the next zone displays.

Enter the 7-digit serial number, using one of the following methods:

- a. Transmit two open and close (or close and open) sequences. For a button-type transmitter, press and release the button, wait approximately 4 seconds, then press and release the button a second time.

OR
- b. Manually enter the 7-digit serial number printed on a label on the transmitter, using the alpha keypad. Then press the [*] key, the cursor will move to the “L” position. You can edit the loop number, if necessary. When the loop number is acceptable, press [*].

OR
- c. Press key [C] to copy the last serial number enrolled (used when programming a transmitter with several input loops).

Remember, you can use the [A] key to move to the right or the [B] key to move to the left.

You can also use the [#] key to back up without saving.

010	INPUT S/N:	L
	A022-4064	1

Press [*] to accept the serial number and advance to the “L” position (if method “a” or “c” was used), then enter the loop number.

If necessary, press the [#] key to back up without saving, and re-enter or edit the serial number before pressing [*] to save

The system checks for a duplicate. If a duplicate serial/loop number combination is found, the keypad will emit a single long beep, and display the serial number along with a “?” for the loop number, allowing you to re-enter the correct loop number.

010	INPUT S/N:	L
	A000-0000	1

To Delete an Existing Serial Number, enter “0” in the loop number field. The serial number will change to “0”s.

If “0” was entered in error, simply re-enter the loop number or press [#], and the serial number will return to the display.

PROMPT	EXPLANATION
<pre>XMIT TO CONFIRM PRESS *TO SKIP</pre>	<p>The prompt to confirm appears. This prompt only appears if you answered “Yes” at the “SET TO CONFIRM?” prompt.</p> <p>The system enters a confirmation mode so that the operation of the actual programmed input can be confirmed. Activate the loop input or button that corresponds to this zone. At any time during this step, you may press the [*] key on the keypad to save the serial and loop number combination without confirming.</p>
<pre>Entd A022-4063 1 Rcvd A022-4064</pre>	<p>If the serial number transmitted <u>does not</u> match the serial number entered, a display similar to the one at the left appears. If the loop number does not match, it also is displayed.</p> <p>If so, activate the loop input or button on the transmitter once again. If a match is not obtained (i.e., summary display for the next zone does not appear), press the [#] key twice and then enter or transmit the correct serial number.</p> <p>Activate the button on the wireless key again after re-entering the serial number.</p>
<pre>Zn ZT P RC In L 011 00 1 10 00 1</pre>	<p>If the serial number transmitted <u>matches</u> the serial number entered, the system beeps 3 times and advances to the summary display for the next zone’s programming.</p> <p>After all the zones have been programmed, enter 000 for the zone number to quit.</p>

After you have enrolled each wireless device, remove ONE of the serial number labels from that device and affix it in the appropriate column on the worksheets provided later in this *Programming Guide*; then enter the other information (zone number, zone type, etc.) relevant to that device.

Entering Wireless Keys

If you pressed the D key previously to enter defaults for 5804 and/or 5804BD wireless keys, the following screens appear:

PROMPT	EXPLANATION
<pre>FROM TEMPLATE 1-6 1</pre>	<p>Enter template number (1–6). 1–3 = 5804 templates; 4–6 = 5804BD templates. See the defaults provided for each template in the chart that follows these procedures.</p> <p>Select from templates. Press [*] to display template (template 1 shown selected).</p> <p>Note: If necessary, press [#] to back up and re-enter template number. Press [#] if you want to return to zone attributes screen.</p>
<pre>L 01 02 03 04 ZT 23 22 21 23 1</pre>	<p>When you press [*], the selected template is displayed. Top line of display represents loop numbers; bottom line represents zone type. Press [*] to accept template.</p>
<pre>PARTITION 1</pre>	<p>Enter partition number for wireless key. Press [*] to continue.</p>
<pre>ENTER ZONE NO 000 = QUIT 024</pre>	<p>The system searches for the highest available, consecutive 4-zone group (the four zones required for the 5804 and 5804BD), and displays the lowest zone number of the group.</p> <p>If you want to start at a different zone number, enter the zone desired and press [*].</p> <p>If that zone number is displayed, the system has the required number of consecutive zones available, beginning with the zone you entered. If not, the system again displays a suggested zone that can be used. If the required number of consecutive zones is not available at all, the system will display “000.”</p> <p>Press [*] to accept.</p>
<pre>024 INPUT S/N L AXXX-XXXX 1</pre>	<p>To enter the serial number: Press and release a button on the wireless key. OR Manually enter the 7-digit serial number printed on the device’s label. Press [*] to accept serial number. The system checks for a duplicate. If a duplicate exists, a long error beep will sound and the serial number reverts back to all “X”s allowing you to re-enter the serial number. Use the [A] key to move forward within the screen, and the [B] key to back up.</p>

▲
Example of zone number suggested by the system. This indicates that zones 24, 25, 26, and 27 are available.

PROMPT	EXPLANATION
--------	-------------

XMIT TO CONFIRM PRESS *TO SKIP

If you entered YES previously at the SET TO CONFIRM prompt (see first prompt following entry into the **Expert Programming Mode**), the display on the left appears.
To confirm, activate the button on the wireless key that corresponds to this zone.

Entd A022-4063
Rcvd A022-4064

If the serial number transmitted does not match the serial number entered, a display similar to the one at the left appears.
If so, activate the loop input or button on the transmitter once again. If a match is not obtained (i.e., summary display does not appear), press the [#] key and then enter the correct serial number.
Activate the button on the wireless key again after re-entering the serial number.

ENTER ZONE NO	028
000 = QUIT	

If the serial number transmitted matches the serial number entered, the system will beep 3 times and revert to the "Start Zone No." prompt and will show the lowest numbered zone of the next available 4-zone group (4 consecutive zones) that is available for programming.
After all the wireless keys have been entered, enter **000** for the zone number to quit.

After you have enrolled each wireless device, remove ONE of the serial number labels from that device and affix it in the appropriate column on the worksheets provided later in this *Programming Guide*; then enter the other information (zone number, zone type, etc.) relevant to that device.

Wireless Key Default Templates

5804				5804BD			
Template 1	Loop	Function	Zone Type	Template 4	Loop	Function	Zone Type
	1	No Response	23		1	No Response	23
	2	Disarming	22		2	No Response	23
	3	Arm AWAY	21		3	Arm AWAY	21
	4	No Response	23		4	Disarming	22
Template 2	Loop	Function	Zone Type	Template 5	Loop	Function	Zone Type
	1	No Response	23		1	No Response	23
	2	Disarming	22		2	Arm STAY	20
	3	Arm AWAY	21		3	Arm AWAY	21
	4	Arm STAY	20		4	Disarming	22
Template 3	Loop	Function	Zone Type	Template 6	Loop	Function	Zone Type
	1	24-Hour Panic	07		1	24-Hour Panic	07
	2	Disarming	22		2	Arm STAY	20
	3	Arm AWAY	21		3	Arm AWAY	21
	4	Arm STAY	20		4	Disarming	22

Report Code Programming

All report codes are entered using #93 Menu Mode Programming, either through Report Code Programming, or through Zone Programming while entering other zone information. In the VISTA-128BP/VISTA-250BP, reports are divided into six categories. These categories represent the main menu options in Report Code Programming. Reports and the categories in which they are found are as follows:

ALARM CODES	RESTR, SUPV. CODES (for groups of 16 zones)	SYSTEM GROUP #1
Zone Alarm Reports	Alarm Restore Trouble Trouble Restore Bypass Bypass Restore	Closing (arm AWAY) Opening (disarm) System Low Battery Low Battery Restore AC Loss AC Restore Periodic Test Power Cancel Program Tamper
SYSTEM GROUP #2	SYSTEM GROUP #3	SYSTEM GROUP #4
Arm STAY Time Set, Log Reset Log 50%, 90% Full Event Log Overflow Exit Error by Zone Exit Error by User Recent Close	Early Open Early Close Late Open Late Close Failed to Open Failed to Close Auto-Arm Failed Schedule Change	Walk-Test Start Walk-Test End

The programming sequence that follows assumes that you will be entering all reports for the system at one time. In actuality, you may skip from one main menu option to another by pressing 0 (N) at each main menu option. To enter report codes, do the following:

Enter Program Mode: [Installer Code] + 8 0 0 0. Then press #93. Enter 0 (N) at each main menu option until the Report Code Programming option is displayed.

PROMPT	EXPLANATION
REPORT CODE PROG 1 = YES 0 = NO 0	Press 1 (Y) to enter to Report Code Programming.
Zone Alarm Reports	
PROMPT	EXPLANATION
ALARM, ID DIGIT? 1 = YES 0 = NO 0	Press [1] (Y) to enter Alarm Report Codes for zones. Press [0] (N) to skip to the next main menu option.
ENTER ZONE NO. 000 = QUIT 001	Enter the zone number for which you are entering the report code. Press [*] to continue.
001 REPORT CODE 1st 00 2nd 00 00	Enter the first digit of the Alarm report code (double-digit entry) and press [*]. Enter the 2nd digit of the Alarm Report code. Press [*] to continue.
ENTER ZONE NO. 000 = QUIT 001	Enter the zone number for which you are entering the report code. When all zone Alarm Codes have been programmed, enter 000 to Quit. Press [*] to continue.
QUIT REPORT MENU 1 = YES 0 = NO 0	If you have completely finished entering report codes, press [1] (Y) to quit Report Code Programming. If you wish to enter other system report codes, enter 0 (N). Press [*] to continue.

Restore/Supervisory Codes

PROMPT	EXPLANATION
RESTR, SUPV. CODE 1 = YES 0 = NO 0	Press [1] (Y) to enter Restore and Supervisory Codes for zones.
ENTER ZN FOR GRP 000 = QUIT 001	Enter one zone for each group of 16 zones (001-016, 017-032, etc.).
ALARM RESTORE GRP 001-016 00	Enter the first digit of the Alarm Restore Report Code for this group of zones (double-digit entry). The second digit (for two-digit reporting formats) is automatically the ID (second) digit of the Alarm Report Code for each zone (if programmed). Press [*] to continue.
TROUBLE GRP 001-016 00	Enter the first digit of the Trouble Report Code for this group of zones (double-digit entry). The second digit (for two-digit reporting formats) is automatically the ID (second) digit of the Alarm Report Code for each zone (if programmed). Press [*] to continue.
TROUBLE RESTORE GRP 001-016 00	Enter the first digit of the trouble restore code (single-digit entry) and press [*] . The second digit (for two-digit reporting formats) is automatically the ID (second) digit of the alarm report code for each zone (if programmed). Press [*] to continue.
BYPASS GRP 001-016 00	Enter the first digit of the Bypass Report Code (double-digit entry) and press [*] . The second digit (for two-digit reporting formats) is automatically the ID (second) digit of the Alarm Report Code for each zone (if programmed). Press [*] to continue.
BYPASS RESTORE GRP 001-016 00	Enter the first digit of the Bypass Restore Report Code (double-digit entry) and press [*] . The second digit (for two-digit reporting formats) is automatically the ID (second) digit of the Alarm Report Code for each zone (if programmed). Press [*] to continue.
ENTER ZN FOR GRP 000 = QUIT 017	Enter one zone for each group of 16 zones. When you are finished entering Restore and Supervisory Codes for all zone groups, enter 000 . Press [*] to continue.
QUIT REPORT MENU 1 = YES 0 = NO 0	If you have completely finished entering report codes, press [1] (Y) to quit <i>Report Code Programming</i> . If you wish to enter other system report codes, enter 0 (N). Press [*] to continue.

System Group #1 Codes

PROMPT	EXPLANATION
SYSTEM GROUP #1? 1 = YES 0 = NO 0	To enter System Group #1 codes, press 1 (Y).
CLOSE 1st 00 2nd 00	Enter the first digit of the Closing (Arm-AWAY) report. Press [*] . Enter the second digit of the report. If the user number is desired as the second digit, enter 01 (not necessary for Contact ID or High Speed formats). Press [*] to continue.

PROMPT	EXPLANATION
	<p>Enter the rest of the codes in the same manner. Other report codes in System Group #1 are:</p> <ul style="list-style-type: none"> • Opening (Disarm) Also, enable this if you desire Callback Requested reports (the panel answers a phone call from the downloader). • System Low Battery • Low Battery Restore • AC Loss • AC Restore • Periodic Test • Power • Cancel • Program Tamper <p>Once you have entered these report codes, the system prompts you with the Quit menu.</p>

<p>QUIT REPORT MENU 1 = YES 0 = NO 0</p>	<p>If you have completely finished entering report codes, press 1 (Y) to quit <i>Report Code Programming</i>. If you wish to enter other system report codes, enter 0 (N). Press [*] to continue.</p>
--	--

System Group #2 Codes

PROMPT	EXPLANATION
--------	-------------

<p>SYSTEM GROUP #2 ? 1 = YES 0 = NO 0</p>	<p>To enter System Group #2 codes, press [1] (Y).</p>
---	--

<p>STAY 1st 00 2nd 00</p>	<p>Enter the first digit of the Arm-STAY report. Press [*]. Enter the second digit of the report. If the user number is desired as the second digit, enter 01 (not necessary for Contact ID or High Speed formats). Press [*] to continue.</p>
-------------------------------	---

	<p>Enter the rest of the codes in the same manner. Other codes in System Group #2 are:</p> <ul style="list-style-type: none"> • Time Set, Log Reset • Log 50%, 90% Full • Event Log Overflow • Exit Error by Zone • Exit Error by User • Recent Close <p>Once you have entered these report codes, the system prompts you with the Quit menu.</p>
--	---

<p>QUIT REPORT MENU 1 = YES 0 = NO 0</p>	<p>If you have completely finished entering report codes, press [1] (Y) to quit <i>Report Code Programming</i>. If you wish to enter other system report codes, enter 0 (N). Press [*] to continue.</p>
--	--

System Group #3 Codes

PROMPT	EXPLANATION
--------	-------------

<p>SYSTEM GROUP #3 ? 1 = YES 0 = NO 0</p>	<p>To enter System Group #3 codes, press [1] (Y).</p>
---	--

<p>EARLY OPEN 1st 00 2nd 00</p>	<p>Enter the first digit of the Early Opening Report Code. Press [*]. Enter the second digit of the report code. If the user number is desired as the second digit, enter 01 (not necessary for Contact ID or High Speed formats). Press [*] to continue.</p>
-------------------------------------	--

PROMPT	EXPLANATION
	<p>Enter the rest of the codes in the same manner. Other codes in System Group #3 are:</p> <ul style="list-style-type: none"> • Early Close • Late Open • Late Close • Failed to Open • Failed to Close • Auto-Arm Failed • Schedule Change <p>Once you have entered these report codes, the system prompts you with the Quit menu.</p>

<p>QUIT REPORT MENU 1 = YES 0 = NO 0</p>	<p>If you have completely finished entering report codes, press [1] (Y) to quit <i>Report Code Programming</i>. If you wish to enter other system report codes, enter 0 (N) Press [*] to continue.</p>
--	--

System Group #4 Codes

PROMPT	EXPLANATION
<p>SYSTEM GROUP #4 ? 1 = YES 0 = NO 0</p>	<p>To enter System Group #4 codes, press [1] (YES).</p>

<p>WALK TEST START 1st 00 2nd 00</p>	<p>Enter the first digit of the Walk Test Start Report Code. Press [*]. Enter the second digit of the report code. Press [*] to continue.</p>
--	---

Enter the rest of the codes in the same manner. Other codes in System Group #4 are:

- Walk-Test End.

Once you have entered these report codes, the system prompts you with the Quit menu.

<p>QUIT MENU MODE? 1 = YES 0 = NO 0</p>	<p>Enter 1 to exit back to normal Programming mode. Enter 0 to stay in Menu mode.</p>
---	---

Alpha Descriptors Programming

You can program a user-friendly English language description/location for all protection zones, relays, keypad panics, polling loop short, and RF receiver supervision troubles.

Each description can be composed of a combination of words (up to 3) that are selected from a vocabulary of 244 words stored in memory, and any word can have an "s" or " 's " added to it.

NOTE: Due to the use of 3-digit zone numbers, the first word of the descriptor is limited to 6 characters if you want it to fit on the top line of the display.

In addition, up to 60 installer-defined words can be added to those already in memory. Thus, when an alarm or trouble occurs in a zone, an appropriate description for the location of that zone will be displayed at the keypad.

A custom installer's message can be programmed for each partition which is displayed when the system is "Ready" (e.g., THE PETERSONS').

1. To program alpha descriptors, enter Programming mode, then press #93 to display "ZONE PROG?"
2. Press [0] (NO) twice to display "ALPHA PROG?".
3. Press [1] to enter *Alpha Programming*.
There are 6 submenu selections that will be displayed one at a time.
Press [1] to select the mode desired.

Press [0] to display the next mode available. The alpha menu selections are:

ZONE DESCRIP?	For entering zone descriptors.
DEFAULT SCREEN?	For creating custom message; displayed when system is ready.
CUSTOM WORD?	For creating custom words for use in descriptors.
PART DESCRIP?	For creating 4-character partition names.
EXIT EDIT MODE?	Press [1] to exit back to #93 Menu Mode.

4. Refer to the sections that follow for procedures for adding alpha descriptors.

Zone Descriptors

1. **Select ZONE DESCRIPTOR mode.**

The keypad keys perform the following functions:

- [3] Scrolls both alphabet and actual words in ascending alphabetical order.
- [1] Scrolls both alphabet and actual words in descending alphabetical order.
- [2] Adds or removes an "s" or " 's " to a vocabulary word.
- [6] Switches between alphabet and actual word list; used to accept entries.
- [8] Saves the zone description in the system's memory.
- [#] [#] plus zone number displays the description for that zone.

2. **Enter the zone number to which you want to assign a descriptor.**

For example, key [*] 001 to begin entering the description for Zone 1, (key [*] 002 for Zone 2, [*] 003 for Zone 3, etc.). The following is displayed: * ZN 001 A.

Note that the first letter of the alphabet appears after the zone number, and that the zone number is automatically included with the description.

3. **Enter the descriptor for that zone.**

Use one of two methods as follows:

(Assume, for example, that the desired description for Zone 1 is BACK DOOR.)

- a) Press [#] followed by the 3-digit number of the first word from the fixed dictionary shown later in this section (e.g., [0][1][3] for BACK).

Press [6] in order to accept the word and proceed, or press [8] to store the complete descriptor and exit;

or

- b) Select the first letter of the desired description (note that "A" is already displayed). Use the [3] key to advance through the alphabet and the [1] key to go backward.

Press [3] key repeatedly until "B" appears (press [1] to go backwards if you happen to pass it), then press [6] to display the first available word beginning with "B".

Press [3] repeatedly to advance through the available words until the word "BACK" is displayed.



To add an "s" or " 's," if you need to, press 2. The first depression adds an "s," the second depression adds an " 's," the third depression displays no character (to erase the character), the fourth depression adds an "s," etc.

4. **Accept the word.**

To accept the word, press [6], which switches back to the alphabet list for the next word, or press [8] to store the complete descriptor and then exit.

5. **Select the next word.**

For selection of the next word (DOOR), repeat step 3a (word #057) or 3b, but selecting the word "DOOR."

To accept the word, press [6], which again switches back to alphabet list.

6. **Store the descriptor.**

When all desired words have been entered, press [8] to store the description in memory.

To review the zone descriptors, key [#] plus zone number (e.g., #001).

To edit zone descriptors, key [*] plus zone number (e.g., *001)

7. Exit Zone Description Mode: enter 000.

Default Screen (Custom Message Display)

Normally, when the system is in the disarmed state, the following display is present on the keypad.

```
****DISARMED****  
READY TO ARM
```

Part or all of the above message can be modified to create a custom installer message for each partition. For example, "****DISARMED****" on the first line or "READY TO ARM" on the second line could be replaced by the installation company name or phone number for service.

Note: There are only 16 character spaces on each of the two lines.

To create a custom display message, proceed as follows:

1. Select Default Screen mode.

The keypad asks for the partition number for this message.

Enter the partition number. Press [*] to accept entry.

The following display appears:

```
****DISARMED****  
READY TO ARM
```

A cursor is present at the extreme left of the first line (over the first "star"). Press [6] to move the cursor to the right and [4] to move the cursor to the left. Press [7] to insert spaces or erase existing characters.

2. Create the message.

For example, to replace "READY TO ARM" with the message "SERVICE 424-0177," proceed as follows:

Press [6] to move the cursor to the right, and continue until the cursor is positioned over the first location on the second line.

Press [3] to advance through the alphabet to the first desired character (in this case, "S"). Press [1] to go backward, when necessary. When the desired character is reached, press [6].

The cursor then moves to the next position, ready for entry of the next character (in this example, "E"). When the cursor reaches a position over an existing character, press [3] or [1] to advance or back up from that character in the alphabet.

Proceed in this manner until all characters in the message have been entered.

3. Save the message.

Store the new display message in memory by pressing [8].

4. The system asks for a new partition number.

Enter 0 to quit or 1-8 for a new partition number.

Custom Words

Up to 60 installer-defined words can be added to the built-in vocabulary. Each of the 60 "words" can actually consist of several words, but bear in mind that a maximum of 10 characters can be used for each word string.

1. Select CUSTOM WORD Mode.

The keys perform the following functions:

[3] Advances through alphabet in ascending order.

[1] Advances through alphabet in descending order.

[6] Selects desired letter; moves the cursor 1 space to the right.

[4] Moves the cursor one space to the left.

[7] Inserts a space at the cursor location, erasing any character at that location.

[8] Saves the new word in the system's memory.

[*] Returns to Description Entry Mode.

2. Enter the custom word number (01-60) you want to create.

For example, if you are creating the first word (or word string), enter 01; when creating the second word, enter 02, and so on. A cursor now appears at the beginning of the second line.

3. Type the word using one of two methods as follows:

a) Press [#], followed by the 2-digit entry for the first letter you would like to display (e.g., 65 for "A").

When the desired character appears, press [6] to select it. The cursor will then move to the right, in position for the next character. Press [#] plus the 2-digit entry for the next letter of the word.

or

b) Press 3 to advance through the list of symbols, numbers, and letters.

Press 1 to move back through the list.

When you have reached the desired character, press [6] to select it. The cursor then moves to the right, in position for the next character.

4. Repeat step 3 to create the desired custom word (or words).

Press [4] to move the cursor to the left if necessary.

Press [7] to enter a blank (or to erase an existing character).

Each word or word string cannot exceed 10 characters.

5. Save the word by pressing [8].

This returns you to the "CUSTOM WORD?" display. The custom word (or string of words) is automatically added to the built-in vocabulary at the end of the group of words beginning with the same letter.

Custom words are retrieved as word numbers 245 to 304 for words 1 to 60, respectively, when using method 3a to enter alpha descriptors.

When using method 3b to enter alpha descriptors, each word appears at the end of the group of words that begin with the same letter as it does.

6. Repeat steps 2 through 6 to create up to a maximum of 60 custom words (or word strings).

7. Exit Custom Word Mode by entering 00 at the "CUSTOM WORD" prompt.

Partition Descriptors

1. Select "Part DESCRIPT." Mode.

The system asks for the partition number desired. Enter the number as a single-key entry 1-8.

2. Follow the same procedure as for custom words.

Note: The partition descriptors are limited to 4 characters (e.g., WHSE for warehouse).

Alpha Descriptor Vocabulary

(For entering alpha descriptors. To select a word, press [#] followed by the word's 3-digit number.)

NOTE: This vocabulary is not to be used for relay voice descriptors. See the *Relay Voice Descriptors* section when programming relay voice descriptors.

000 (Word Space)	• 052 DETECTOR *	102 INTERIOR	151 POLICE *	• 201 TOOL
• 001 AIR	• 053 DINING *	103 INTRUSION	152 POOL *	202 TRANSMITTER
• 002 ALARM *	054 DISCRIMINATOR	104 JEWELRY	• 153 POWER	203 TRAP
003 ALCOVE	055 DISPLAY	• 105 KITCHEN *	154 QUAD	204 ULTRA
004 ALLEY	056 DOCK	• 106 LAUNDRY *	155 RADIO	• 205 UP
005 AMBUSH	• 057 DOOR *	• 107 LEFT	• 156 REAR	• 206 UPPER
• 006 AREA	058 DORMER	108 LEVEL	157 RECREATION	• 207 UPSTAIRS *
• 007 APARTMENT	• 059 DOWN	• 109 LIBRARY *	158 REFRIG	• 208 UTILITY
008 ART	• 060 DOWNSTAIRS	• 110 LIGHT	159 REFRIGERATION	209 VALVE
• 009 ATTIC *	061 DRAWER	• 111 LINE	160 RF	210 VAULT
010 AUDIO	• 062 DRIVEWAY	112 LIQUOR	• 161 RIGHT	211 VIBRATION
011 AUXILIARY	063 DRUG	• 113 LIVING *	• 162 ROOM *	212 VOLTAGE
• 012 BABY *	• 064 DUCT	• 114 LOADING	163 ROOF	213 WALL
• 013 BACK *	• 065 EAST	115 LOCK	164 SAFE	214 WAREHOUSE
• 014 BAR	066 ELECTRIC	116 LOOP	165 SCREEN	215 WASH
015 BARN	067 EMERGENCY *	117 LOW	166 SENSOR	• 216 WEST
• 016 BASEMENT *	068 ENTRY	• 118 LOWER	• 167 SERVICE	• 217 WINDOW *
• 017 BATHROOM *	• 069 EQUIPMENT	• 119 MACHINE	• 168 SHED *	218 WINE
• 018 BED	070 EXECUTIVE	120 MAGNETIC	• 169 SHOCK	• 219 WING
• 019 BEDROOM *	• 071 EXIT *	121 MAIDS	• 170 SHOP *	220 WIRELESS
020 BELL	072 EXTERIOR	122 MAIN *	171 SHORT	221 WORK
• 021 BLOWER	• 073 FACTORY	• 123 MASTER *	172 SHOW	222 XMITTER
• 022 BOILER	074 FAILURE	124 MAT	• 173 SIDE *	• 223 YARD *
023 BOTTOM	075 FAMILY	• 125 MEDICAL *	174 SKYLIGHT	224 ZONE (No.)
024 BOX	• 076 FATHERS	126 MEDICINE	• 175 SLIDING *	• 225 ZONE *
025 BREAK	• 077 FENCE	127 MICROWAVE	• 176 SMOKE *	• 226 0 *
• 026 BUILDING	078 FILE	128 MONEY	177 SONIC	• 227 1
027 BURNER	• 079 FIRE *	129 MONITOR	• 178 SONS	• 228 1ST *
028 CABINET	• 080 FLOOR *	• 130 MOTHERS	180 SPRINKLER	• 229 2
• 029 CALL	081 FLOW	• 131 MOTION *	181 STAMP	• 230 2ND *
030 CAMERA	082 FOIL	132 MOTOR	• 182 STATION	• 231 3
031 CAR	• 083 FOYER	133 MUD	183 STEREO	• 232 3RD *
032 CASE	084 FREEZER	• 134 NORTH	184 STORE	• 233 4
033 CASH	• 085 FRONT *	135 NURSERY	• 185 STORAGE *	• 234 4TH
034 CCTV	086 FUR	• 136 OFFICE *	186 STORY	• 235 5
035 CEILING	087 FURNACE	137 OIL	187 STRESS	• 236 5TH
036 CELLAR	088 GALLERY	• 138 OPEN *	188 STRIKE	• 237 6
• 037 CENTRAL	• 089 GARAGE *	139 OPENING	189 SUMP	• 238 6TH
038 CIRCUIT	• 090 GAS	• 140 OUTSIDE	• 190 SUPERVISED *	• 239 7
039 CLIP	091 GATE	141 OVERFLOW	191 SUPERVISION	• 240 7TH
• 040 CLOSED *	• 092 GLASS	142 OVERHEAD	192 SWIMMING	• 241 8
041 COIN	093 GUEST	143 PAINTING	193 SWITCH	• 242 8TH
042 COLD	094 GUN *	• 144 PANIC *	194 TAMPER	• 243 9
043 COATROOM	• 095 HALL *	145 PASSIVE	195 TAPE	• 244 9TH
044 COLLECTION	• 096 HEAT	• 146 PATIO *	196 TELCO	245 Custom Word 1
045 COMBUSTION	097 HIGH	147 PERIMETER	197 TELEPHONE	to
• 046 COMPUTER	098 HOLDUP	• 148 PHONE	198 TELLER	304 Custom Word 60
047 CONTACT	• 099 HOUSE *	149 PHOTO	• 199 TEMPERATURE	
• 048 DAUGHTERS	100 INFRARED	150 POINT	200 THERMOSTAT	
049 DELAYED	• 101 INSIDE *			
• 050 DEN *				
051 DESK				

CHARACTER (ASCII) CHART

(For Adding Custom Words)

32 (space)	42 *	52 4	62 >	72 H	82 R
33 !	43 +	53 5	63 ?	73 I	83 S
34 "	44 ,	54 6	64 @	74 J	84 T
35 #	45 -	55 7	65 A	75 K	85 U
36 \$	46 .	56 8	66 B	76 L	86 V
37 %	47 /	57 9	67 C	77 M	87 W
38 &	48 0	58 :	68 D	78 N	88 X
39 '	49 1	59 ;	69 E	79 O	89 Y
40 (50 2	60 <	70 F	80 P	90 Z
41)	51 3	61 =	71 G	81 Q	

Notes: This factory-provided vocabulary of words is subject to change.

Bulleted words in **bold face type** are those that are also available for use by the 4285/4286 VIP Module. If you are using a VIP Module, and words other than these are selected for alpha descriptors, the Voice Module will not provide annunciation of those words.

Words *italicized* followed by an asterisk indicate those words supported by the 6160V Voice keypad.

Device Programming

This menu is used to program keypads, receivers, and relay modules, etc.



Device Address **00** is always set as an alpha keypad assigned to Partition 1 with no sounder suppression options, and these settings cannot be changed.

From Data Field Programming mode, press **#93** to display "ZONE PROG?" Press **[0]** repeatedly to display "DEVICE PROG?"

PROMPT	EXPLANATION		
<div style="border: 1px solid black; padding: 5px;"> DEVICE PROG? 1=YES 0=NO 0 </div>	Press [1] to enter <i>Device Programming</i> .		
<div style="border: 1px solid black; padding: 5px;"> DEVICE ADDRESS 01-30, 00=QUIT 01 </div>	The device address identifies the device to the control. Enter the 2-digit device address number to match the device's physical address setting (01-30). Notes: <ul style="list-style-type: none"> • Device Address 01 is defaulted for an AUI (Symphony) with Keypad Global arm/disarm disabled. • Device Address 04 must be used for the 4285/4286 Voice Module, if one is utilized. If not, it can be used for another device type. • Device Address 24 must be used for TeleSmart, if one is utilized. If not, it can be used for another device type. If using TeleSmart, you must program Device Address 23 as an alpha console. Do not connect an actual keypad set to address 23 to the control panel. This setup is necessary for remote access of TeleSmart. Press [*] to accept entry.		
<div style="border: 1px solid black; padding: 5px;"> DEVICE TYPE 00 </div>	Select the type of addressable device as follows: <table style="width: 100%; border: none;"> <tr> <td style="width: 50%; vertical-align: top;"> <ul style="list-style-type: none"> 00 = device not used 01 = alpha keypad (6139/6160, AUI) 03 = RF receiver (5881) 04 = output relay module (4204) 05 = voice (VIP) Module (4285/4286) </td> <td style="width: 50%; vertical-align: top;"> <ul style="list-style-type: none"> 06 = long range radio 08 = fire display (FSA) 09 = Vista Gateway Module (VGM) 10 = panel link module 11 = Telesmart </td> </tr> </table> Press [*] to accept entry.	<ul style="list-style-type: none"> 00 = device not used 01 = alpha keypad (6139/6160, AUI) 03 = RF receiver (5881) 04 = output relay module (4204) 05 = voice (VIP) Module (4285/4286) 	<ul style="list-style-type: none"> 06 = long range radio 08 = fire display (FSA) 09 = Vista Gateway Module (VGM) 10 = panel link module 11 = Telesmart
<ul style="list-style-type: none"> 00 = device not used 01 = alpha keypad (6139/6160, AUI) 03 = RF receiver (5881) 04 = output relay module (4204) 05 = voice (VIP) Module (4285/4286) 	<ul style="list-style-type: none"> 06 = long range radio 08 = fire display (FSA) 09 = Vista Gateway Module (VGM) 10 = panel link module 11 = Telesmart 		

Alpha Keypad

PROMPT	EXPLANATION
<div style="border: 1px solid black; padding: 5px;"> 01 CONSOLE PART. 1 </div>	If you selected device type 01 (alpha keypad), this prompt appears. Enter the addressable device's default partition number (01 to maximum number of partitions programmed for system in field 2*00). This is the primary partition for the device. Enter 9 to make this keypad a "Master" keypad for the system. Press [*] to accept entry.
<div style="border: 1px solid black; padding: 5px;"> 01 SOUND OPTION 00 </div>	If you entered device type 01 (alpha keypad), this prompt appears. Keypads can be individually programmed to suppress arm/disarm beeps, entry/exit beeps and chime mode beeps. This helps prevent unwanted sounds from disturbing users in other areas of the premises. Enter a number 00-03 for the keypad sounding suppression options desired for the keypad as follows: <ul style="list-style-type: none"> 00 = no suppression 01 = suppress arm/disarm & entry/exit beeps 02 = suppress chime mode beeps only 03 = suppress arm/disarm, entry/exit and chime mode beeps Press [*] to accept entry.
<div style="border: 1px solid black; padding: 5px;"> 01 KEYPAD GLBL? 0 </div>	If you entered device type 01 (alpha keypad), this prompt appears. Each keypad can give users with access to multiple partitions the ability to arm and disarm those partitions from it. To enable this keypad for global arming/disarming, enter 1 . To prevent the ability to use this keypad for global arming/disarming, enter 0 . Press [*] to accept entry.

PROMPT	EXPLANATION
--------	-------------

01 AUI ? 1 = YES 0 = NO 0	If you selected device type 01 (alpha keypad), this prompt appears. Enter 1 (YES) if the device is an AUI (Symphony 8112, 8122, 8132, or 8142). See the Symphony's instructions for the installation and operation. Press [*] to accept entry.
-----------------------------------	--

RF Expander

PROMPT	EXPLANATION
--------	-------------

01 RF EXPANDER HOUSE I 00	If you selected device type 03 (RF receiver), this prompt appears. Enter the 2-digit House ID (00-31). This is required if you are using a wireless keypad (5827/5827BD). Press [*] to accept entry.
---	---

Output Relay Module

PROMPT	EXPLANATION
--------	-------------

01 SUPERVISED CF? 0	If you selected device type 04 (relay module), this prompt appears. Enter 1 if the unit is a 4204CF. If not, enter 0. If you enter 1, only Relay 1 (Output A) and Relay 3 (Output B) on each module may be programmed for functions. This module is usually used to add two additional supervised bell outputs to the system. Press [*] to accept entry.
--	---

Long Range Radio

If you selected device type 6, the 6139/6160 Keypad functions similarly to the 7720PLRR Programming Tool. See *Figure 1* for the functions of the keys on the 6139.

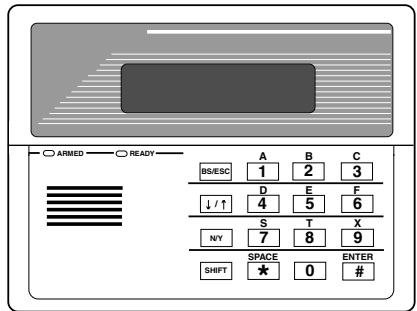

SHIFT function indicated by turning on READY LED.

Figure 1: 6139 Key Functions for Programming 7820 Radio

Each key has two possible functions: a normal function and a SHIFT function. To perform a normal key function, simply press the desired key. To perform a SHIFT key function, press SHIFT key, then press desired function key.

Normal and SHIFT key Functions:

Key	Normal Key Function	SHIFT Key Function
BS/ESC	[BS]: Press to delete entry Also, can reset EEPROM defaults *	[ESC]: Press to quit Program Mode
↓/↑	[↓]: Scroll down programming	[↑]: Scroll up programming
N/Y	[N]: Press for "NO" answer	[Y]: Press SHIFT-Y for "YES" answer
SHIF T	Press before pressing a SHIFT key function. Will light READY LED. LED goes out once a key is pressed. Press again for each SHIFT function desired.	
1/A	[1]: For entering the number 1	[A]: Used for entering C.S. ID number
2/B	[2]: For entering the number 2	[B]: Used for entering C.S. ID number
3/C	[3]: For entering the number 3	[C]: Used for entering C.S. ID number
4/D	[4]: For entering the number 4	[D]: Used for entering C.S. ID number
5/E	[5]: For entering the number 5	[E]: Used for entering C.S. ID number
6/F	[6]: For entering the number 6	[F]: Used for C.S. ID & FAST Mode
7/S	[7]: For entering the number 7	[S]: Press to display diagnostic status
8/T	[8]: For entering the number 8	[T]: Press to send TEST messages
9/X	[9]: For entering the number 9	[X]: Press to reset the 7820
/SPACE	[]: Not used with 7820	[SPACE]: Not used with 7820
0	[0]: For entering the number 0	No SHIFT function
#/ENTER	[#/ENTER]: Press to accept entries	No SHIFT function

* Active only when the "REVIEW?" prompt is displayed.

The 6139/6160 Keypad displays the following prompts, which are sent by the Long Range Radio transmitter to the control.
Note: These prompts are for the 7820 Radio only. If you are using a different radio, refer to the radio's instructions for the correct prompts.

PROMPT	EXPLANATION
DEVICE ADDRESS	Enter the device address of the radio. The default address is 3.
ID # (1234)	Enter the 4-digit customer account number, 0001-9999 . This ID number will appear in the messages generated by the radio. Messages generated by the panel and transmitted by the radio will contain the ID number programmed into the panel. The radio and the panel should have the same ID number, if possible.



If a different 4-digit customer account number is used in the radio than is programmed into the alarm control, the radio will transmit radio-specific messages (power-on reset, AC fail, etc.) using the radio customer number, and alarm messages using the control panel's customer number. If these numbers are different, you will be billed for two AlarmNet radio accounts.

PROMPT	EXPLANATION
ODD [Y/N] (N)	Enter Y for odd system flag; N for even system flag.
Alarmnet (Y/N) (Y)	Enter Y if this is an AlarmNet installation. Enter N if this is a private system and skip to Question 7.
CS ID (11)	Enter the primary central station's system ID number, 1-7F (will not be displayed for private system users).
BAT PRESENT [Y/N] (N)	Enter Y if optional battery will be used. Must be Y for UL installations (a battery must be installed).
USE RADIO # [Y/N] (N)	If you selected Y , the Radio ID number replaces the panel Subscriber ID in panel-generated messages. If you selected N , the radio sends panel-generated messages with the panel Subscriber ID number.
2 ND CS ID (12)	This must be programmed with a value, even if it is the same as the primary central station. The alarm panel has the option of sending a selected message to the second central station.
REVIEW (Y/N) (N)	Enter Y to review the programming options and to ensure that the correct responses have been made. Parameters can be changed during review. Enter N to end programming session.

Panel Linking Module

PROMPT	EXPLANATION
01 PANEL ID# (01-08) 01	If you selected device type 10 (panel linking module), this prompt appears. Enter the panel's ID # (01-08). Each panel must have its own unique ID #. This device is supervised as zone "8xx," where "xx" = the device's address. If you want to supervise this device, program that zone with response type 05. If you want to supervise panel link modules from other controls, also program them into <i>Zone Programming</i> on a regular zone (001-250) with a response type of 14. Press [*] to accept entry.

VIP Module, VISTA Gateway Module and Panel Linking Module

PROMPT	EXPLANATION
<div style="border: 1px solid black; padding: 5px; display: inline-block;"> 01 MODULE PART. 1 </div>	If you selected device type 05 (VIP Module), type 09 (VGM) or type 10 (PLM), this prompt appears. Enter the partition number 1-8 in which the module is located. Press [*] to accept entry. Press 00 + [*] to exit Menu mode. Press *99 to exit Program mode.

Output Programming

The system supports up to 96 outputs. Outputs can be used to perform many different functions and actions. Each output must be programmed to begin one of four types of ACTIONS at a designated START event, and end that ACTION at a designated STOP event. The options used to start and stop these devices are described below, followed by the actual screen prompts and available entries.

The letter(s) in parentheses after each function described below, such as (A) after ACTION, are those that appear in the various summary displays of programmed data during programming.

ACTION (A) The "ACTION" of the device is how the device will respond when it is activated by the "START" programming. You may want the device to activate momentarily, to pulse on and off continuously, or to remain activated until some other event occurs to stop it. There are five different action choices:

- ACTIVATE for 2 SECONDS and then reset.
- ACTIVATE and REMAIN ACTIVATED until stopped by some other event.
- PULSE ON and OFF until stopped by some other event (do not use with an FSA device).
- NO RESPONSE when the device is not used.
- TOGGLE on and off alternately with each activation of event.

START (STT) The "START" programming determines when and under what conditions the device is activated. The following START options are available:

- 1) **EVENT (EV)** is the condition (alarm, fault, trouble) that must occur to a zone or group of zones (zone list) in order to activate the device. These conditions apply *only* when a zone list is used. The different choices for "EVENT" are listed below and in "Programming Relays" later in this section.
 - ALARM Action begins upon any alarm in an assigned zone in the zone list.
 - FAULT Action begins upon any opening of an assigned zone in the zone list.
 - TROUBLE Action begins upon any trouble condition in an assigned zone in the zone list.
 - NOT USED Action is not dependent upon one of the above events.

ZONE LIST (ZL) is a group of zones to which the "EVENT" applies in order to activate a particular device. Note that there are a total of 15 zone lists that can be programmed; when the selected EVENT (alarm, fault or trouble) occurs in **any** zone in the selected "Start" ZONE LIST (01-15), activation of the selected device will START.

- 2) **ZONE #** A specific zone going into alarm, fault, trouble, or restore (Event programming) can be used to start the relay action. Enter the 3-digit zone number (000-250).
- 3) **ZONE TYPE/SYSTEM OPERATION (ZT)**. If all zones to be used to start the device have the same response type, and there are no other zones of this type that are **not** to activate this device, then "ZONE TYPE" may be used instead of a "ZONE LIST" and "EVENT" to activate the device.

If a system operation, such as "DISARMING" or "ANY FIRE ALARM," is to activate the device, enter the appropriate choice under the "ZONE TYPE" option.

The "ZONE TYPE/SYSTEM OPERATION" option functions independently of the "EVENT/ZONE LIST" combination.

If a specific "ZONE TYPE" is chosen, any zone of that response type going into alarm, trouble, or fault will cause the device to activate as selected in "ACTION." If the same "ZONE TYPE" is also chosen for the STOP programming, any zone of that type that *restores* will de-activate the device.

If a "SYSTEM OPERATION" is chosen, that operation will cause the device to activate as selected in "ACTION." The different choices for "ZONE TYPE" and "SYSTEM OPERATION" are listed in "Programming Relays" later in this section, and on the Programming Form.

- 4) **PARTITION NO. (P)**. The device's "Start" ZONE TYPE/SYSTEM OPERATION may be limited to an occurrence on one partition (1-8), or any partition (0).

STOP (STP): The "STOP" programming determines when and under what conditions the device is de-activated. The following options are available:

- 1). **RESTORE ZONE LIST (ZL).** If a "ZONE LIST" is used as the "Stop" event, the device de-activates when **all** the zones in that list restore from a previous fault, trouble, or alarm condition. This occurs regardless of what is programmed to "START" the device; therefore, a "RESTORE ZONE LIST" is normally only used when a "ZONE LIST" is used to start the device.
- 2). **ZONE TYPE/SYSTEM OPERATION (ZT).** Instead of using a "RESTORE ZONE LIST," you can select a specific zone (response) type or system operation action to de-activate the device.
 If you choose a specific "ZONE TYPE," any zone of that response type that restores from a previous alarm, trouble, or fault condition will cause the device to de-activate.
 If you choose a "SYSTEM OPERATION," that operation causes the device to de-activate. The different choices for "ZONE TYPE" and "SYSTEM OPERATION" are listed in "Programming Relays" later in this section, and in the Programming Form.
- 3) **PARTITION NO. (P).** The device's "Stop" Zone Type/System Operation may be limited to an occurrence on one partition (1-8), or on any partition (0).

The "ZONE TYPE/SYSTEM OPERATION" option functions independently of the "RESTORE/ZONE LIST" combination.

Output Devices Programming

From Data Field Programming Mode, press **#93** to display the "ZONE PROG?" prompt. Press **[0]** (NO) to each menu option until the "OUTPUT PGM?" prompt appears. Press **[1]** (YES).

While in this mode, press **[*]** to advance to next screen. Press **[#]** to back up to the previous screen.

PROMPT	EXPLANATION
ENTER RELAY # (00=QUIT) 01	Enter the relay (output device) identification number 01-96 . This is a reference number only, used for identification purposes. The actual module address and relay number on the module are programmed in the last two prompts. Press [*] to continue.
02 A EV ZL ZT P STT 0 0 00 00 0	Press [*] to continue.
02 A ZL ZT P STOP 0 00 00 0	The keypad displays a summary STOP screen. Press [*] to continue.
02 RELAY ACTION NO RESPONSE 0	The Relay Action is the way in which the relay will respond when activated by the "start" event. Enter the desired action for this relay as follows: 0 =not used; 1 =close for 2 secs.; 2 =stay closed; 3 =pulse on/off; 4 = toggle on and off alternately
02 START EVENT NOT USED 0	An output may be activated by an Event/Zone List combination, and/or by a Zone Type/System Operation. For an Event/Zone List combination, enter the event code as follows: 0 =not used; 1 =alarm; 2 =fault; 3 =trouble If you are not using a Zone List to activate the relay, enter 0 . Press [*] to continue.
02 START: ZN LIST 00	A zone list is a set of zones that can be used to initiate the start or stop relay action. If a zone list is being used to start this relay action, enter the zone list number, 1-15 . If a zone list is not being used, enter 0 . Press [*] to continue.
02 START: ZONE # 000	A specific zone can be used instead of or in addition to an Event/Zone List or Zone Type/System Operation combination to start the relay action. Enter the 3-digit zone number. Press [*] to continue.
02 START: ZN TYPE NO RESPONSE 00	A Zone Type/System Operation can be used instead of or in addition to an Event/Zone List combination or a specific zone to start the relay action. If a Zone Type/System Operation is being used, enter the 2-digit code as listed in the table that follows. Press [*] to continue.

Choices for Start/Stop Zone Types and System Operations:

00 = No Response (Not Used)	23 = No Alarm Response	41 = AC Power Fail
01 = Entry/Exit #1	27 = Access Point (allows more than one relay to be controlled by activation if access point request)	42 = System Battery Low
02 = Entry/exit #2	28 = MLB Supervision	43 = Communication failure
03 = Perimeter	29 = Momentary Exit	44 = RF Low Battery
04 = Interior Follower	31 = End of Exit Time	45 = Polling Loop Failure
05 = Trouble Day/Alarm Night	32 = Start of Entry Time	47 = Console Failure
06 = 24-Hr. Silent	33 = Any Burglary Alarm	51 = RF Receiver Failure
07 = 24-Hr. Audible	34 = Code + [#] + 71 Key Entry	52 = KISSOFF
08 = 24-Hr. Auxiliary	35 = Code + [#] + 72 Key Entry	54 = Fire Zone Reset
09 = Fire Alarm or Trouble	36 = At Bell Timeout **	55 = Disarm + 1 Minute
10 = Interior W/Delay	37 = 2 Times Bell Timeout **	56 = XX Minutes (enter XX in field 1*74) *
14 = PLM Supervision	38 = Chime	57 = YY Seconds (enter YY in field 1*75) *
16 = Fire With Verification	39 = Fire Alarm	58 = Duress
20 = Arming-STAY***	40 = Bypassing	60 = Audio Alarm Verification (must be selected for both START and STOP operation)
21 = Arming-AWAY****		
22 = Disarming (Code + Off)		

- * Stop condition only
- ** Or at disarming, whichever occurs earlier
- *** The output also activates when the partition is armed in the INSTANT mode
- **** The output also activates when the partition is armed in the MAXIMUM mode



If you are using options 56 and/or 57 (usually as the STOP Zone Type), you must program data fields 1*74 and 1*75 for the respective relay timeouts for minutes and seconds.

PROMPT	EXPLANATION
02 START: ACS PT (00-31) 00	If the start zone type you selected was 27 (access point), this prompt is displayed. Enter the access point (00-31) that will start the relay action. Press [*] to continue.
02 START: PARTN ANY PARTITION 0	If the starting event will be limited to occurring on a specific partition, enter the partition number (1-8) in which the start event will occur. Enter 0 for any partition. Press [*] to continue.



Do not use a zone programmed with an RF Button (Input Type BR) to STOP a relay. The system will not deactivate the relay.

PROMPT	EXPLANATION
02 STOP: ZN LIST 00	If a zone list is being used to stop this relay action, enter the zone list number, 1-15 . The restore of a zone on the zone list stops the relay. If a zone list is not being used, enter 0 . Press [*] to continue.
02 STOP: ZN TYPE NO RESPONSE 00	If a Zone Type/System Operation is being used to stop the relay action, enter the 2-digit code listed in the Choices for Start/Stop System Operation chart. Press [*] to continue.
02 STOP: ACS PT (00-31) 00	If the stop zone type you selected was 27 (access point), this prompt is displayed. Enter the access point (00-31) which will stop the relay action. Press [*] to continue.
02 STOP: PARTN ANY PARTITION 0	This is the partition to which the stop condition will be limited. Enter 0 for any partition. Enter 1-8 for specific partition number. Press [*] to continue.

PROMPT	EXPLANATION																		
02 RELAY GROUP 00	Relays may be grouped for common activation by time-driven events (commands 06-10). Enter 00 (no group) or 01-15 for a specific group number. Press [*] to continue.																		
02 RESTRICTION 1=YES 0=NO 0	The system may have some devices that are not intended to be under end user control, such as relays activating fire doors or machinery. Enter 1 if the end user will be restricted from accessing this relay group. Press [*] to continue.																		
02 RELAY TYPE V-PLEX 0	Enter 0 for V-Plex (polling loop) devices. Enter 1 for (ECP) relay modules (4204/4204CF). Enter 2 for X10 devices. Enter 3 for (FSA) Fire System Annunciator. Press [*] to continue.																		
02 V-PLEX ZONE # 000	For polling loop trigger outputs (4101SN), enter the protection zone number (001-250) linked to each output, if used. Be sure to enroll the module's serial number (see Zone Programming). Press [*] to continue.																		
02 ECP ADDRESS 00	If you selected 1 or 3 for (4204/4204CF or FSA), enter the actual module's address (01-15 – 4204/4204CF) (08-23 – FSA) as set by its DIP switches. Up to 8 4204/4204CF modules and up to 4 FSA modules can be installed in a system. Press [*] to continue.																		
02 MODULE RELAY# 0	For 4204 Relay Outputs, enter the specific relay number on that module (1-4). For 4204CF outputs, enter only module relay number 1 (Output A) or relay number 3 (Output B) . These are the only two programmable relays on the 4204CF Module. Press [*] to continue. The keypad will display the Start and Stop summary screens again. Press [*] to continue.																		
02 HOUSE CODE A 00	If you selected 2 for X-10 devices, enter the numerical equivalent of the House Code of the device, as follows: <table style="margin-left: 40px;"> <tr> <td>A=00</td> <td>D=03</td> <td>G=06</td> <td>J=09</td> <td>M=12</td> <td>P=15</td> </tr> <tr> <td>B=01</td> <td>E=04</td> <td>H=07</td> <td>K=10</td> <td>N=13</td> <td></td> </tr> <tr> <td>C=02</td> <td>F=05</td> <td>I=08</td> <td>L=11</td> <td>O=14</td> <td></td> </tr> </table>	A=00	D=03	G=06	J=09	M=12	P=15	B=01	E=04	H=07	K=10	N=13		C=02	F=05	I=08	L=11	O=14	
A=00	D=03	G=06	J=09	M=12	P=15														
B=01	E=04	H=07	K=10	N=13															
C=02	F=05	I=08	L=11	O=14															
02 UNIT CODE 00	Enter the numerical unit code of the X-10 device (00-15). Press [*] to continue. The keypad displays the Start and Stop summary screens again. Press [*] to continue.																		
01 LED # 00	Enter the LED number on the FSA module (01-08 for FSA-8; 01-24 for FSA-24). Press [*] to continue. The keypad displays the Start and Stop summary screens again. Press [*] to continue.																		

When all relays have been programmed, enter **00** at the "ENTER RELAY NO." prompt.

If you are defining a zone list, continue to the next section. If not, enter **00 + [*]** at the next two prompts. You will then be asked "Quit Menu Mode?" Enter **1** for "Yes," **0** for "No." Then enter ***99** to exit programming completely.

If supervision of the 4204CF Relay Output is desired, enter a response type for that output's corresponding supervisory zone. This is equal to 600 + [Relay ID No.]. For example, if you are programming Relay ID No. 1, the relay's supervisory zone 601. Program this zone with response type 05 (Day/Night) in *Zone Programming*.

Zone List Programming

After all relays have been programmed, upon entering **00** at the "ENTER RELAY NO." prompt, you are asked to enter a zone list. If a zone list number was used to start or stop a relay, you must define the zones belonging to that list as follows:

PROMPT	EXPLANATION
ENTER Zn LIST ? 00=QUIT 00	Enter the zone list number 01-15 . Enter 00 to quit.

PROMPT	EXPLANATION
01 ADD ZONE # 000=QUIT 000	Using 3-digit entries, enter each zone to be included in this zone list. Press [*] after you enter each zone number. When you have entered all zones, enter 000. Press [*] to continue.
01 Del Zn LIST ? 1=YES 0=NO 0	Enter 0 to save this zone list. Enter 1 to delete it.
01 DEL ZONES ? 1=YES 0=NO 0	Enter 1 to delete one or more zones in that zone list. Enter 0 if no changes are necessary. If you enter 1, the following screen appears; otherwise, the "Enter Zone LIST" prompt reappears.
01 Zn to DELETE ? 000=QUIT 000	Enter each zone number to be deleted from the zone list, pressing [*] after each number.
VIEW Zn LIST ? 00=QUIT 00	This display appears if you pressed 00 at the "Enter Zone LIST" prompt. Enter the zone list number that you wish to view. Press [*] to continue.
01 ASSIGNED ZONE 000=QUIT 000	Press [*] to scroll through all zones in that list. Enter 000 +[*] to quit. Press [1] to exit Menu Mode. Press *99 to exit Program Mode.

Relay Voice Descriptors

If you are using the 4285/4286 VIP Module, voice descriptors can be programmed for outputs 1-32 (even though the system has 96 outputs, only 1-32 can have a Relay Voice Descriptor programmed). These descriptors are announced by the voice module when you access the relays via the # 70 Relay Access Mode over the telephone.

Each voice descriptor can consist of up to 3 words selected from the Relay Voice Descriptors and Custom Word Substitutes Vocabulary list (later in this section).



The index numbers from this vocabulary list are to be used for relay voice descriptors only. For normal system voice annunciation (e.g., alarms, troubles, status), use the highlighted words in the alpha vocabulary list in the *Alpha Programming* part of this guide.

To enter relay voice descriptors, do the following:

1. From Data Field Programming mode, press #93 to display the "ZONE PROG?" prompt.
2. Press [0] (NO) to each menu option until the "RLY VOICE DESCR?" prompt is displayed. Follow the instructions below. While in this mode, press [*] to advance to next screen. Press [#] to back up to previous screen.

PROMPT	EXPLANATION
RLY VOICE DESCR? 1=YES 0=NO 0	Press [1] to program voice descriptors for relays.
ENTER RELAY NO. 00=QUIT 01	Enter the 2-digit relay number (01-32) for the relay desired, or enter 00 to quit Relay Voice Descriptor Programming Mode. Press [*]
01 ENTER DESC d1	From the Relay Voice Descriptors and Custom Word Substitutes Vocabulary list, enter the 3-digit index number for the first word of the relay descriptor phrase. Press [*] to accept entry.

PROMPT	EXPLANATION
--------	-------------

01 ENTER DESC d2	From the Relay Voice Descriptors and Custom Word Substitutes Vocabulary list, enter the 3-digit index number for the second word of the relay descriptor phrase. If second word is not desired, press [000] . Press [*] to accept entry.
------------------	--

01 ENTER DESC d3	From the Relay Voice Descriptors and Custom Word Substitutes Vocabulary list, enter the 3-digit index number for the third word of the relay descriptor phrase. If third word is not desired, press [000] . Press [*] to accept entry. The "ENTER RELAY NO." prompt appears. Enter the next relay number to be programmed. When you have programmed all output devices, enter 00 to quit. Enter *99 to exit Program Mode.
------------------	---

Relay Voice Descriptors and Custom Word Substitutes Vocabulary

Words *italicized* indicate those words supported by the 6160V Voice keypad.

Word	Index	Word	Index	Word	Index	Word	Index	Word	Index
Air	116	Daughter's	208	Front	087	No	165	Side	153
Alarm	255	Den	052	Garage	023	North	146	Six	075
And	067	Detector	128	Gas	138	Not	012	Sixth	219
Apartment	117	Device	060	Glass	139	Off	011	Smoke	024
Appliances	161	Dim	163	Hall	050	Office	147	Son's	223
Area	118	Dining	031	Heat	010	On	058	South	155
Attic	119	Door	016	Inside	209	One	070	Stairs	006
Baby	120	Down	008	Kitchen	022	Open	148	Station	156
Back	121	Downstairs	184	Laundry	140	Outside	210	Storage	157
Bar	122	Driveway	130	Left	027	Panic	013	Sun	154
Basement	021	Duct	131	Light	019	Partition	090	System	062
Bathroom	051	East	132	Living	030	Patio	149	Temperature	158
Battery	053	Eight	077	Loading	142	Phone	061	Third	159
Bed	092	Eighth	221	Lower	094	Power	063	Three	072
Bedroom	015	Equipment	133	Machine	143	Pump	166	Tool	213
Blower	123	Exit	004	Master	144	Rear	088	Two	071
Boiler	124	Factory	134	Medical	014	Right	028	Up	025
Bright	162	Father's	211	Mother's	212	Room	018	Upper	187
Building	125	Fence	135	Motion	145	's	007	Upstairs	183
Burglary	039	Fifth	218	Nine	078	Second	056	Utility	185
Call	009	Fire	040	Ninth	222	Service	150	West	215
Central	089	First	136	Room	018	Seven	076	Window	017
Chime	054	Five	074	Shop	152	Seventh	220	Wing	216
Closed	126	Floor	029	Shed	151	Zero	069	Zone	002
Computer	127	Four	073	Shop	152				
Console	066	Fourth	217						
		Foyer	137						

Custom Word Substitutes for VIP Module Annunciation

A substitute word can be programmed for each of the 60 custom words used in your alpha zone descriptions. The VIP Module announces this substitute word in place of the custom word that is displayed on the alpha keypad. For example, an alarm display of "John's Bedroom" could be announced as "Son's Bedroom," as there is no annunciation for the custom word "John." Note that if a substitute word is not assigned, the VIP Module will not annunciate the zone descriptor at all, but will only annunciate the zone number.

To enter custom word substitutes, do the following:

- From Data Field Programming Mode, press **#93** to display the "ZONE PROG?" prompt.
- Press **[0]** (NO) to each menu option until the "CUSTOM INDEX ?" prompt is displayed.

PROMPT	EXPLANATION
--------	-------------

CUSTOM INDEX ? 1=YES 0=NO 0	Enter [1] at this prompt.
--------------------------------	----------------------------------

CUSTOM WORD NO. 00=QUIT	Enter the custom word number (01-60) for which a voice substitute is desired. Enter 00 to quit this Programming Mode. Press [*] to accept entry.
----------------------------	---

PROMPT	EXPLANATION
01 ENTER INDEX #	Enter the 3-digit substitute word index number from the Relay Voice Descriptors and Custom Word Substitutes Vocabulary list in the <i>Relay Voice Descriptors</i> part of this section. Press [*] to accept entry. The "CUSTOM WORD NO." prompt is displayed. Enter the next custom word number to be substituted, or enter 00 to quit.

Scheduled Check-in

The system can be programmed to call the downloader automatically, at a scheduled time. Once the connection is made, the downloader can perform any and all functions (arm, disarm, upload, etc.). The downloader determines the functions it performs.

To enter scheduled check-in, do the following:

1. From Data Field Programming mode, press #93 to display the "ZONE PROG?" prompt.
2. Press [0] (NO) to each menu option until the "SCHEDULED CHK-IN" prompt is displayed.

PROMPT	EXPLANATION
SCHEDULED CHK-IN 1=YES 0=NO 0	Enter [1] at this prompt.
Chk-In Interval None 0	Enter the check-in interval. 0 = None; 1 = Weekly; 2 = Monthly; 3 = Quarterly; 4 = Yearly. Press [*] to accept entry.
DAY: M T W T F S S 1 2 3 4 5 6 7 1	If you selected 1 (weekly), the Day of the Week prompt is displayed. Enter the day of the week (1-7). Press [*] to accept entry and move to the Time of the Day prompt.
Quarter of Year JAN, APR, JUL, OCT 0	If you selected 3 (quarterly), the Quarter of the Year prompt is displayed. Enter the quarter of the year. 0 = January, April, July, and October; 1 = February, May, August, and November; 2 = March, June, September, and December. Press [*] to accept entry and move to the Day of the Month prompt.
Month of Year (01-12) 01	If you selected 4 (yearly), the Month of Year prompt is displayed. Enter the month (01-12). Press [*] to accept entry and move to the Day of the Month prompt.
Day of Month (01-28) 01	If you selected 2 (monthly), the Day of the Month prompt is displayed. Enter the day of the month (01-28). Press [*] to accept entry and move to the Time of the Day prompt.
Time of Day 12:00AM	The Time of the Day prompt is displayed. Enter the time of day for the check-in. Enter the hour of the day (01-12). Press [*] to accept entry. The cursor moves to the minutes position. (Press the [#] to move the cursor backwards.) Enter the minutes of the hour (00-59). Press [*] to accept entry. The cursor moves to the AM/PM position. Press [*] to accept the current selection or press any key (1-9) except the [*] or [#] to toggle the AM/PM selection. NOTE: The programming of field 1*71 determines the time of day format (12- or 24-hour).
QUIT MENU MODE? 1 = YES 0 = NO 0	Enter 1 to exit back to normal programming mode. Enter 0 to stay in menu mode.

System Layout Worksheets

Before programming any security system, you should first define the installation. To help you lay out a partitioned system, use the following worksheets. This will further simplify the programming process.

NOTE: All references in this manual for number of zones, number of user codes, number of access cards, and the event log capacity, use the VISTA-250BP's features. See page 2 of this manual for the table listing the differences between the VISTA-128BP and the VISTA-250BP control panels. All other features are identical, except for the Remote Keypad Sounder (field 1*46 option 2), which is available only in the VISTA128BP.

PARTITIONS

Partition #	Descriptor (4-char max)	Prim. Sub. #	Sec. Sub. #	Alpha Default Message (32-character maximum)
Partition 1				
Partition 2				
Partition 3				
Partition 4				
Partition 5				
Partition 6				
Partition 7				
Partition 8				
Keyswitch Arming Partition Assignment (1-8):				
Wireless Keypad Partition Assignment (1-8):				
Voice Module Partition Assignment (1-8):				
Use Partition Descriptor (yes/no)?				
Common Lobby Partition Assignment (1-8):				

COMMUNICATION OPTIONS BY PARTITION

Option	Part. 1	Part. 2	Part. 3	Part. 4	Part. 5	Part. 6	Part. 7	Part. 8
Swinger Suppression Count 00-15; 00=no suppression								
Cancel Report After Disarm								
Dialer Reports for Panic (* + 1)								
Dialer Reports for Panic (# + 3)								
Dialer Reports for Panic (* + #)								
Dialer Reports for Duress								
Burglary Alarm Communications Delay (16 sec.)								

SYSTEM DEFINITIONS BY PARTITION (enter values or yes/no)

Option	Part. 1	Part. 2	Part. 3	Part. 4	Part. 5	Part. 6	Part. 7	Part. 8
Entry Delay #1 (00, 30-225 seconds):								
Exit Delay #1 (00, 45-225 seconds):								
Entry Delay #2 (00, 30-225 seconds):								
Exit Delay #2 (00, 45-225 seconds):								
Quick Arming								
Multiple Alarms per Arming								
Console Panic for Zone 995 (* + 1)								
Console Panic for Zone 996 (# + 3)								
Console Panic for Zone 999 (* + #)								
Allow Sign-on (GOTO function)								
Non-Bypassable Zone*								
Sounder Timeout Duration for Bell (2 min. increments)								
Console Annunciation During Entry**								
Console Annunciation During Exit								
Confirmation of Arming Ding for Bell								
Chime on Bell								
Access Control Relay (field 1*76)								
Affects Lobby (check partitions that apply)								
Arms Lobby (check partitions that apply)								
Displays Fire Alarms of Other Partitions								
Displays Burg & Panic Alarms of Other Partitions								
Displays Troubles of Other Partitions								

*Can be any zone 001-250. **no= 3 beeps yes=continuous

PRINTER OPTIONS

Parallel or Serial printer	
12- or 24-hour Time format	
Printer On-Line (yes/no)	
*1200 or 300 baud Printer Baud Rate	

*Note: Must be 1200 if using pager interface

EVENT LOG TYPES

Option	No	Yes
Alarm		
Trouble		
Bypass		
Open/Close		
System		

DEVICES (keypads, 4204, rf receivers, vip module, lrr, vgm, TeleSmart plm)

Addr	Type	Part	Sound Opt	Supv CF?	House ID	Kypd Gibal	AUI	Panel ID
00.								
01.								
02.								
03.								
04.								
05.								
06.								
07.								
08.								
09.								
10.								
11.								
12.								
13.								
14.								
15.								
16.								
17.								
18.								
19.								
20.								
21.								
22.								
23.								
24.								
25.								
26.								
27.								
28.								
29.								
30.								

Device Types:

- 00 = Device Not Used
- 01 = Alpha Console
- 03 = RF Receiver
- 04 = Output Relay Module
- 05 = Voice Module
- 06 = Long Range Radio
- 08 = Fire Display Module
- 09 = Vista Gateway Module
- 10 = Panel Link Module
- 11 = TeleSmart

NOTES:

Address 04 must be used for the Voice Module, if used.
Address 24 must be used for TeleSmart, if used.
If using TeleSmart, program address 23 as an alpha console, but do not connect a console with that address.

Console Sounder Options:

- 0 = No Suppression
- 1 = Suppress Arm/Disarm and Entry/Exit Beeps
- 2 = Suppress Chime Mode Beeps Only
- 3 = Suppress Arm/Disarm, Entry/Exit and Chime Mode Beeps

Defaults:

Addresses 00 = Alpha Keypad; No Suppression
 Addresses 01 = AUI, Keypad Global disabled

ACCESS CODES & USER DEFINITIONS FOR PARTITIONS 1 & 2

4-digit Security Code	Access Group 0; 1-8	Partition 1						Partition 2						
		3-Digit User #	Auth. Level	Open/Close	Group Bypass	RF Key	Global Arm	3-Digit User #	Auth. Level	Open/Close	Group Bypass	RF Key	Global Arm	

--	--	--	--	--	--	--	--	--	--	--	--	--	--	--

ACCESS CODES & USER DEFINITIONS FOR PARTITIONS 3 & 4

4-digit Security Code	Access Group 0; 1-8	Partition 3						Partition 4						
		3-Digit User #	Auth. Level	Open/Close	Group Bypass	RF Key	Global Arm	3-Digit User #	Auth. Level	Open/Close	Group Bypass	RF Key	Global Arm	

ACCESS CODES & USER DEFINITIONS FOR PARTITIONS 5 & 6

4-digit Security Code	Access Group 0; 1-8	Partition 5						Partition 6						
		3-Digit User #	Auth. Level	Open/Close	Group Bypass	RF Key	Global Arm	3-Digit User #	Auth. Level	Open/Close	Group Bypass	RF Key	Global Arm	

ACCESS CODES & USER DEFINITIONS FOR PARTITIONS 7 & 8

4-digit Security Code	Access Group 0; 1-8	Partition 7						Partition 8						
		3-Digit User #	Auth. Level	Open/Close	Group Bypass	RF Key	Global Arm	3-Digit User #	Auth. Level	Open/Close	Group Bypass	RF Key	Global Arm	

- Authority Levels: 1=Master (arm, disarm, bypass, and/or modify lower level users)
 2=Manager (arm, disarm, bypass, and/or modify lower level users)
 3=Operator A (arm, disarm, bypass)
 4=Operator B (arm, disarm)
 5=Operator C (arm, disarm only if system was armed with this code)
 6=Duellus code (arm, disarm, triggers silent panic alarm)

Defaults:

User	4-Digits	Alpha
User 1 (Installer)	4140	INSTLR
User 2	1234	MASTER

ZONE DEFINITION FOR ZONES 001-025

Zone No.	Zone Type	Part 1-8	Input Type	Arm w/Fault	Vent Zone	STAY Mode	Auto-STAY	Silent	Bypass Group	Access Point	Panel ID #	Tamper	Serial # / Loop	Rpt. Code	Zone Information (part numbers) & Alpha Descriptor (3 words)
1															
2															
3															
4															
5															
6															
7															
8															
9															
10															
11															
12															
13															
14															
15															
16															
17															
18															
19															
20															
21															
22															
23															
24															
25															

ZONE DEFINITION FOR ZONES 026-050

Zone No.	Zone Type	Part 1-8	Input Type	Arm w/Fault	Vent Zone	STAY Mode	Auto-STAY	Silent	Bypass Group	Access Point	Panel ID #	Tamper	Serial # / Loop	Rpt. Code	Zone Information (part numbers) & Alpha Descriptor (3 words)
26															
27															
28															
29															
30															
31															
32															
33															
34															
35															
36															
37															
38															
39															
40															
41															
42															
43															
44															
45															
46															
47															
48															
49															
50															

ZONE DEFINITION FOR ZONES 051-075

Zone No.	Zone Type	Part 1-8	Input Type	Arm w/Fault	Vent Zone	STAY Mode	Auto-STAY	Silent	Bypass Group	Access Point	Panel ID #	Tamper	Serial # / Loop	Rpt. Code	Zone Information (part numbers) & Alpha Descriptor (3 words)
51															
52															
53															
54															
55															
56															
57															
58															
59															
60															
61															
62															
63															
64															
65															
66															
67															
68															
69															
70															
71															
72															
73															
74															
75															

ZONE DEFINITION FOR ZONES 076-100

Zone No.	Zone Type	Part 1-8	Input Type	Arm w/Fault	Vent Zone	STAY Mode	Auto-STAY	Silent	Bypass Group	Access Point	Panel ID #	Tamper	Serial # / Loop	Rpt. Code	Zone Information (part numbers) & Alpha Descriptor (3 words)
76															
77															
78															
79															
80															
81															
82															
83															
84															
85															
86															
87															
88															
89															
90															
91															
92															
93															
94															
95															
96															
97															
98															
99															
100															

ZONE DEFINITION FOR ZONES 101-125

Zone No.	Zone Type	Part 1-8	Input Type	Arm w/Fault	Vent Zone	STAY Mode	Auto-STAY	Silent	Bypass Group	Access Point	Panel ID #	Tamper	Serial # / Loop	Rpt. Code	Zone Information (part numbers) & Alpha Descriptor (3 words)
101															
102															
103															
104															
105															
106															
107															
108															
109															
110															
111															
112															
113															
114															
115															
116															
117															
118															
119															
120															
121															
122															
123															
124															
125															

ZONE DEFINITION FOR ZONES 126-150

Zone No.	Zone Type	Part 1-8	Input Type	Arm w/Fault	Vent Zone	STAY Mode	Auto-STAY	Silent	Bypass Group	Access Point	Panel ID #	Tamper	Serial # / Loop	Rpt. Code	Zone Information (part numbers) & Alpha Descriptor (3 words)
126															
127															
128															
129															
130															
131															
132															
133															
134															
135															
136															
137															
138															
139															
140															
141															
142															
143															
144															
145															
146															
147															
148															
149															
150															

ZONE DEFINITION FOR ZONES 151-175

Zone No.	Zone Type	Part 1-8	Input Type	Arm w/Fault	Vent Zone	STAY Mode	Auto-STAY	Silent	Bypass Group	Access Point	Panel ID #	Tamper	Serial # / Loop	Rpt. Code	Zone Information (part numbers) & Alpha Descriptor (3 words)
151															
152															
153															
154															
155															
156															
157															
158															
159															
160															
161															
162															
163															
164															
165															
166															
167															
168															
169															
170															
171															
172															
173															
174															
175															

ZONE DEFINITION FOR ZONES 176-200

Zone No.	Zone Type	Part 1-8	Input Type	Arm w/Fault	Vent Zone	STAY Mode	Auto-STAY	Silent	Bypass Group	Access Point	Panel ID #	Tamper	Serial # / Loop	Rpt. Code	Zone Information (part numbers) & Alpha Descriptor (3 words)
176															
177															
178															
179															
180															
181															
182															
183															
184															
185															
186															
187															
188															
189															
190															
191															
192															
193															
194															
195															
196															
197															
198															
199															
200															

ZONE DEFINITION FOR ZONES 201-225

Zone No.	Zone Type	Part 1-8	Input Type	Arm w/Fault	Vent Zone	STAY Mode	Auto-STAY	Silent	Bypass Group	Access Point	Panel ID #	Tamper	Serial # / Loop	Rpt. Code	Zone Information (part numbers) & Alpha Descriptor (3 words)
201															
202															
203															
204															
205															
206															
207															
208															
209															
210															
211															
212															
213															
214															
215															
216															
217															
218															
219															
220															
221															
222															
223															
224															
225															

ZONE DEFINITION FOR ZONES 226-250

Zone No.	Zone Type	Part 1-8	Input Type	Arm w/Fault	Vent Zone	STAY Mode	Auto-STAY	Silent	Bypass Group	Access Point	Panel ID #	Tamper	Serial # / Loop	Rpt. Code	Zone Information (part numbers) & Alpha Descriptor (3 words)
226															
227															
228															
229															
230															
231															
232															
233															
234															
235															
236															
237															
238															
239															
240															
241															
242															
243															
244															
245															
246															
247															
248															
249															
250															

ZONE DEFINITIONS FOR KEYPAD PANIC ZONES 995, 996, & 999

Zone No.	Zone Type	Enter yes/no for each partition-field *22								Report Code	Zone Information (part numbers) & Alpha Descriptor (3 words max.)
		1	2	3	4	5	6	7	8		
995											
996											
999											

ZONE DEFINITIONS FOR SYSTEM ZONES; 970, 988; 990 & 997

Zone No.	Zone Type	Report Code	Zone Information (part numbers) & Alpha Descriptor (3 words max.)
970			
988			
990			
997			

NOTE: When supervising the bell output (zone 970), only one device can be connected to the alarm output (terminals 4 and 5) for UL and Fire installations.

ZONE DEFINITIONS FOR RELAY SUPERVISORY ZONES 601-632

Zone No.	Zone Type	Report Code	Zone Information (part numbers) & Alpha Descriptor (3 words max.)	Zone No.	Zone Type	Report Code	Zone Information (part numbers) & Alpha Descriptor (3 words max.)
601				617			
602				618			
603				619			
604				620			
605				621			
606				622			
607				623			
608				624			
609				625			
610				626			
611				627			
612				628			
613				629			
614				630			
615				631			
616				632			

ZONE DEFINITIONS FOR SUPERVISORY OF ECP DEVICE ZONES 800-830

Zone No.	Zone Type	Report Code	Zone Information (part numbers) & Alpha Descriptor (3 words max.)	Zone No.	Zone Type	Report Code	Zone Information (part numbers) & Alpha Descriptor (3 words max.)
800				816			
801				817			
802				818			
803				819			
804				820			
805				821			
806				822			
807				823			
808				824			
809				825			
810				826			
811				827			
812				828			
813				829			
814				830			
815							

Zone Types:

00=zone not used	07=24-hour audible	21=arm away
01=entry/exit 1	08=24-hour auxiliary	22=disarm
02=entry/exit 2	09=supervised fire	23=no alarm response
03=perimeter	10=interior (delay)	27=access control
04=interior (follower)	14=panel link supervision	28=MLB supervision
05=day/night burglary	16=fire w/verification	29=momentary exit
06=24-hour silent	20=arm stay	

Input Types:

00=not used	07=Dip switch-type polling loop
01=hardwired	08=right loop dip switch polling loop
02=RF motion transmitter	09=keypad input
03=supervised RF transmitter	10=PassPoint ACS input
04=unsupervised RF transmitter	11=VistaKey door status monitor
05=RF button transmitter	12=VistaKey request to exit
06=serial number polling loop	13=VistaKey general purpose

Output Devices Worksheets

Applicable only if relays (4204/4204CF), FSA Modules, V-Plex or X-10 devices are used.

Output Devices – Programmed in the #93 Menu Mode in the Output Programming Section. Fill in the required data on the worksheet below and follow the procedure in the installation instructions as you enter the data during the displays and prompts that appear in sequence.

- Notes:**
1. For 4204/4204CF and FSA, the Device Programming section must be programmed for the device address. Set the DIP switches on the device for that address.
 2. For V-Plex, the devices must be programmed in the Zone Programming section.
 3. For X-10 devices, use the 1361X10 transformer in place of the transformer that comes in the box with the control panel.

OUTPUT DEV #	A	S T A R T			S T O P			Relay Group	Restrict	0=V-Plex 1=4204 2=X-10 3=FSA	V-Plex Zone # or Dev Add 4204 or FSA or House Code for X-10	Relay # for 4204 or LED # for FSA or Unit Code for X-10
		EV/ZL	Zone	ZT / P	ZL	ZT / P						
1.												
2.												
3.												
4.												
5.												
6.												
7.												
8.												
9.												
10.												
11.												
12.												
13.												
14.												
15.												
16.												
17.												
18.												
19.												
20.												

OUTPUT DEVICES WORKSHEET (cont'd)

OUTPUT DEV #	A	S T A R T			S T O P			Relay Group	Restrict	0=V-Plex 1=4204 2=X-10 3=FSA	V-Plex Zone # or Dev Add 4204 or FSA or House Code for X-10	Relay # for 4204 or LED # for FSA or Unit Code for X-10
		EV/ZL	Zone	ZT / P	ZL	ZT / P						
21.												
22.												
23.												
24.												
25.												
26.												
27.												
28.												
29.												
30.												
31.												
32.												
33.												
34.												
35.												
36.												
37.												
38.												
39.												
40.												
41.												
42.												
43.												
44.												
45.												

OUTPUT DEVICES WORKSHEET (cont'd)

OUTPUT DEV #	A	S T A R T				S T O P			Relay Group	Restrict	0=V-Plex 1=4204 2=X-10 3=FSA	V-Plex Zone # or Dev Add 4204 or FSA or House Code for X-10	Relay # for 4204 or LED # for FSA or Unit Code for X-10
		EV/ZL	Zone	ZT / P		ZL	ZT / P						
46.													
47.													
48.													
49.													
50.													
51.													
52.													
53.													
54.													
55.													
56.													
57.													
58.													
59.													
60.													
61.													
62.													
63.													
64.													
65.													
66.													
67.													
68.													
69.													
70.													

OUTPUT DEVICES WORKSHEET (cont'd)

OUTPUT DEV #	A	S T A R T			S T O P			Relay Group	Restrict	0=V-Plex 1=4204 2=X-10 3=FSA	V-Plex Zone # or Dev Add 4204 or FSA or House Code for X-10	Relay # for 4204 or LED # for FSA or Unit Code for X-10
		EV/ZL	Zone	ZT / P	ZL	ZT / P						
71.												
72.												
73.												
74.												
75.												
76.												
77.												
78.												
79.												
80.												
81.												
82.												
83.												
84.												
85.												
86.												
87.												
88.												
89.												
90.												
91.												
92.												
93.												
94.												
95.												
96.												

- A = DEVICE ACTION** 0 = No Response; 1 = Close for 2 sec; 2 = Close and stay closed; 3 = Pulse on and off; 4 = Toggle alternately between START and STOP events
- EV = EVENT** 0 = Not used; 1 = Alarm; 2 = Fault; 3 = Trouble; 4 = Restore
- ZL = ZONE LIST** 01-15, 00 = Not Used
- "START" ZONE LIST: Upon alarm, fault, trouble or restore of ANY zone in this list, device action will START.
- "STOP" ZONE LIST: Upon restore of ALL zones on this list, device action will STOP. It need not be same list as used for START.

ZT = ZONE TYPE/SYSTEM OPERATION

Choices for Zone Types are:

00=zone not used	07=24-hour audible	21=arm away
01=entry/exit 1	08=24-hour auxiliary	22=disarm
02=entry/exit 2	09=supervised fire	23=no alarm response
03=perimeter	10=interior (delay)	26=VGM supervision
04=interior (follower)	14=PLM supervision	27=access control
05=day/night burglary	16=fire w/verification	28=MLB supervision
06=24 hour silent	20=arm stay	29=momentary exit

NOTE: Any zone in "ZT" for Start, going into alarm, fault, or trouble will activate the relay. Any zone in "ZT" for Stop, that restores will stop the relay action.

Choices for System Operation are:

00 = No Response (Not Used)	27 = Access Point (allows more than one relay to be controlled by activation if access point request)	42 = System Battery Low
01 = Entry/Exit #1	28 = MLB Supervision	43 = Communication failure
02 = Entry/exit #2	29 = Momentary Exit	44 = RF Low Battery
03 = Perimeter	31 = End of Exit Time	45 = Polling Loop Failure
04 = Interior Follower	32 = Start of Entry Time	47 = Console Failure
05 = Trouble Day/Alarm Night	33 = Any Burglary Alarm	51 = RF Receiver Failure
06 = 24-Hr. Silent	34 = Code + [#] + 71 Key Entry	52 = Kissoff
07 = 24-Hr. Audible	35 = Code + [#] + 72 Key Entry	54 = Fire Zone Reset
08 = 24-Hr. Auxiliary	36 = At Bell Timeout **	55 = Disarm + 1 Minute
09 = Fire Alarm or Trouble	37 = 2 Times Bell Timeout **	56 = XX Minutes (enter XX in field 1*74) *
10 = Interior W/Delay	38 = Chime	57 = YY Seconds (enter YY in field 1*75) *
16 = Fire With Verification	39 = Fire Alarm	58 = Duress
20 = Arming-STAY***	40 = Bypassing	60 = Audio Alarm Verification (must be selected for both START and STOP operation)
21 = Arming-AWAY****	41 = AC Power Fail	
22 = Disarming (Code + Off)		
23 = No Alarm Response		

- * Stop condition only
- ** Or at Disarming, whichever occurs earlier
- *** The output also activates when the partition is armed in the INSTANT mode
- **** The output also activates when the partition is armed in the MAXIMUM mode

P = PARTITION No. 1-8, 0 = Any

ZONE LISTS FOR OUTPUT DEVICES – Programmed in the #93 Menu Mode in the Output Programming Section. Fill in the required data on the worksheet below and follow the procedure shown earlier in this *Programming Guide* as you enter the data during the displays and prompts that appear in sequence. Up to 15 zone lists may be created

Note: Record desired zone numbers below. More or fewer boxes than shown may be needed, as any list may include *any* or *all* of system's zone numbers.

Zone List 1: Started or stopped by zone numbers (enter 000 to end entries).

<input type="text"/>	<input type="text"/>	<input type="text"/>	<input type="text"/>	<input type="text"/>	<input type="text"/>	<input type="text"/>
<input type="text"/>	<input type="text"/>	<input type="text"/>	<input type="text"/>	<input type="text"/>	<input type="text"/>	<input type="text"/>

Zone List 2: Started or stopped by zone numbers (enter 000 to end entries).

<input type="text"/>	<input type="text"/>	<input type="text"/>	<input type="text"/>	<input type="text"/>	<input type="text"/>	<input type="text"/>
<input type="text"/>	<input type="text"/>	<input type="text"/>	<input type="text"/>	<input type="text"/>	<input type="text"/>	<input type="text"/>

Zone List 3: Started or stopped by zone numbers (enter 000 to end entries).

Zone List 4: Started or stopped by zone numbers (enter 000 to end entries).

Zone List 5: Started or stopped by zone numbers (enter 000 to end entries).

Zone List 6: Started or stopped by zone numbers (enter 000 to end entries).

Zone List 7: Started or stopped by zone numbers (enter 000 to end entries).

Zone List 8: Started or stopped by zone numbers (enter 000 to end entries).

Zone List 9: Started or stopped by zone numbers (enter 000 to end entries).

Zone List 10: Started or stopped by zone numbers (enter 000 to end entries).

Zone List 11: Started or stopped by zone numbers (enter 000 to end entries).

Zone List 12: Started or stopped by zone numbers (enter 000 to end entries).

Zone List 13: Started or stopped by zone numbers (enter 000 to end entries).

Zone List 14: Started or stopped by zone numbers (enter 000 to end entries).

<input type="text"/>	<input type="text"/>	<input type="text"/>	<input type="text"/>	<input type="text"/>	<input type="text"/>	<input type="text"/>
<input type="text"/>	<input type="text"/>	<input type="text"/>	<input type="text"/>	<input type="text"/>	<input type="text"/>	<input type="text"/>

Zone List 15: Started or stopped by zone numbers (enter 000 to end entries).

<input type="text"/>	<input type="text"/>	<input type="text"/>	<input type="text"/>	<input type="text"/>	<input type="text"/>	<input type="text"/>
<input type="text"/>	<input type="text"/>	<input type="text"/>	<input type="text"/>	<input type="text"/>	<input type="text"/>	<input type="text"/>

Scheduling Menu Prompts

To program schedules, enter Scheduling program mode by pressing **[User Code] + # + 80** to display the first choice of the menu driven programming functions. **NOTE:** Only users with an Installer or Master level user code may enter the #80 mode. Press **0** (NO) or **1** (YES) in response to the displayed menu selection. Pressing **0** will display the next choice in sequence. Menu selections are as follows:

PROMPT	EXPLANATION
Time Window ? 1 = YES 0 = NO 0	For defining up to 20 time windows each with a start and a stop time programmed by entering the hours and minutes.
O/C Schedules ? 1 = YES 0 = NO 0	For defining the daily open and close schedules for the 8 partitions. Each partition can be programmed with an opening and closing window for each day of the week and holidays.
Holidays ? 1 = YES 0 = NO 0	For defining up to 16 holidays for which partitions they apply.
Timed Events ? 1 = YES 0 = NO 0	For defining up to 20 time driven events with the following parameters: <ul style="list-style-type: none"> • Time window • Action desired • Action specifier • Activation time • Days of the week
Access Sched. ? 1 = YES 0 = NO 0	For defining the limitation of access schedules for the user codes. Each schedule can be programmed with two window for each day of the week and holidays

#80 & #81 MENU MODE KEY COMMANDS

The following is a list of commands used while in the Menu mode.

#80 or #81	Enters Menu mode
[*]	Serves as ENTER key. Press to have keypad accept entry.
[#]	Backs up to previous screen.
0	Press to answer NO.
1	Press to answer YES.
01-09	All data entries are either 2-digit entries.
00	Exits Menu mode, returns to normal operation mode when entered at the first question for each category.

Scheduling Worksheets

Time Windows Definitions Worksheet. The system provides 20 time windows that are defined with start and stop times. They are programmed in the #80 Menu Mode. Fill in the required data on the worksheet below and follow the procedure in the installation instructions as you enter the data during the displays and prompts that appear in sequence.

Time Window Number	Start Time (HH:MM)	Stop Time (HH:MM)
1		
2		
3		
4		
5		
6		
7		
8		
9		
10		
11		
12		
13		
14		
15		
16		
17		
18		
19		
20		

(Keep this worksheet handy, as you will be asked for a given time window number later in this section).



Because the time windows are shared among all partitions, it is important to make sure that changing a time window does not adversely affect desired actions in other partitions.

Daily Open/Close Schedule Worksheet: Using the time windows previously defined, fill in the required data on the worksheet below and follow the procedure in the installation instructions as you enter the data during the displays and prompts that appear in sequence.

Part	Mon		Tues		Wed		Thur		Fri		Sat		Sun		Hol	
	Op	Cl	Op	Cl	Op	Cl	Op	Cl	Op	Cl	Op	Cl	Op	Cl	Op	Cl
1																
2																
3																
4																
5																
6																
7																
8																

Holiday Schedule Worksheet: The system provides up to 16 holidays that can be assigned for the system. Each holiday can be assigned to any combination of partitions. Fill in the required data on the worksheet below and follow the procedure in the installation instructions as you enter the data during the displays and prompts that appear in sequence.

HOL	Partition								
	Month/Day	1	2	3	4	5	6	7	8
1	/								
2	/								
3	/								
4	/								
5	/								
6	/								
7	/								
8	/								
9	/								
10	/								
11	/								
12	/								
13	/								
14	/								
15	/								
16	/								

Time-Driven Event Worksheet: The system provides up to 20 time-driven events that can be programmed for the system. Fill in the required data on the worksheet below and follow the procedure in the installation instructions as you enter the data during the displays and prompts that appear in sequence.

Sched Num.	Time Window	Day(s)								Action Desired	Action Specifier	Activation Time
		M	T	W	T	F	S	S	H			
1												
2												
3												
4												
5												
6												
7												
8												
9												
10												
11												
12												
13												
14												
15												
16												
17												
18												
19												
20												

Automatic Refresh: The system automatically updates the status of all Time-Driven Events upon any of the following occurrences:

- Changing of the time or date via #63 mode
- Exiting #80 Scheduling Menu mode
- Exiting Program mode
- After a disconnect from the downloader
- On a power-up
- At Daylight Saving Time adjustment.

Below is a list of the "Action" codes (desired actions) used when programming time-driven events. Note that these codes are independent of the "relay codes" programmed during the #93 Menu Mode–Output Programming mode. **If using Time Driven Events, the following menu items must first be programmed using #93 Menu Mode - Output Programming:**

Enter Relay No. (reference identification number)	ECP Address (4204/4204CF or FSA)
Relay Group (if applicable)	Relay No. (4204/4204CF)
Restriction	LED No. (FSA)
Relay Type (V-Plex, 4204/4204CF, FSA, or X-10)	House Code (X-10)
Zone No. (V-Plex)	Unit Code (X-10)

Relay commands:

Action Specifier for commands 01-05 is Relay No.; Action Specifier for commands 06-10 is Relay Group No.

- | | |
|--|--|
| 01 = Relay On | 02 = Relay Off |
| 03 = Relay Close for 2 seconds | 04 = Relay Close XX minutes (field 1*74) |
| 05 = Relay Close YY seconds (field 1*75) | 06 = Relay Group On |
| 07 = Relay Group Off | 08 = Relay Group Close for 2 seconds |
| 09 = Relay Group Close XX minutes (field 1*74) | 10 = Relay Group Close YY seconds (field 1*75) |

Arm/Disarm commands:

Action Specifier for commands 20-24 is Partition(s). Activation times 1 (Beginning), 2 (End), 3 (During), 5 (Random Start), 6 (Random End), 7 (Random During) are the only valid choices for auto-arming and disarming functions.

- | | |
|---|---|
| 20 = Arm-Stay | 21 = Arm Away |
| 22 = Disarm | 23 = Force Arm Stay (Auto-bypass faulted zns) |
| 24 = Force Arm Away (Auto-bypass faulted zns) | 25 = Arm Instant |
| 26 = Arm Maximum | |

Bypass commands:

Action Specifier for commands 30-31 is Zone List #, Activation times 1 (Beginning), 2 (End), 3 (During), 5 (Random Start), 6 (Random End), 7 (Random During) are the only valid choices for bypass commands.

- | | |
|------------------------------|--------------------------------|
| 30 = Auto bypass - Zone list | 31 = Auto unbypass - Zone list |
|------------------------------|--------------------------------|

Open/Close Windows:

Action Specifier for commands 40-41 is Partition(s), and for 42 is Access Group. Activation time 3 (During), 7 (Random During) are the only valid choices for these commands.

- | | | |
|----------------------------|----------------------------|---------------------------|
| 40 = Enable Opening Window | 41 = Enable Closing Window | 42 = Enable Access Window |
|----------------------------|----------------------------|---------------------------|

Access Control Commands

Action Specifier for commands 55-60 is Access Point, for 61-66 is Group, for 67-72 is Partition, and for 73-74 is Trigger.

- | | |
|--|---|
| 55 = Access Point Grant | 56 = Access Point Grant with Override |
| 57 = Access Point Protect | 58 = Access Point Bypass |
| 59 = Access Point Lock | 60 = Access Point Exit |
| 61 = Access Point Group Grant | 62 = Access Point Group Grant with Override |
| 63 = Access Point Group Protect | 64 = Access Point Group Bypass |
| 65 = Access Point Group Lock | 66 = Access Point Group Exit |
| 67 = Access Point Partition Grant | 68 = Access Point Partition Grant with Override |
| 69 = Access Point Protect by Partition | 70 = Access Point Bypass by Partition |
| 71 = Access Point Lock by Partition | 72 = Access Point Exit by Partition |
| 73 = Access Point Trigger On | 74 = Access Point Trigger Off |

Additional Commands

Action Specifier for command 78 is Group.

- 78 = Access Point Group Disable

Activation time:

Refers to when the action is to take place relative to the time window.

- 1 = Beginning of time window
- 2 = End of time window
- 3 = During time window active period only (On at beginning of window, off at end).
- 4 = Beginning and end of time window
- 5 = Random Start of the time window *
- 6 = Random End of the time window *
- 7 = Random During the time window *

- * The activation time of the window is randomized up to 30 minutes and is initialized by either of two methods:
 - a. **[User Code] + [#] + [41]** – Initiates the random schedule for all devices in the partition.
 - b. **[User Code] + [#] + [42]** – Initiates the random schedule for all devices in the partition with a time window within 6 PM and 5 AM.

Limitation of Access Worksheet The system provides up to 8 Access Schedules that can be programmed for the system. Fill in the required data on the worksheet below and follow the procedure in the installation instructions as you enter the data during the displays and prompts that appear in sequence.

Acc Sch	Mon		Tues		Wed		Thurs		Fri		Sat		Sun		Hol	
	W1	W2	W1	W2	W1	W2	W1	W2	W1	W2	W1	W2	W1	W2	W1	W2
1																
2																
3																
4																
5																
6																
7																
8																

Temporary Schedule #81 Menu Mode. The system provides a Temporary Schedule for each partition. Enter the temporary scheduling mode by pressing **[Installer Code] + [#] + [81]**. Fill in the required data on the worksheet below and follow the procedure in the installation instructions as you enter the data during the displays and prompts that appear in sequence.

Partition/Windows		Mon	Tue	Wed	Thu	Fri	Sat	Sun
1	Disarm Window							
	Start Time HH:MM							
	Stop Time HH:MM							
	Arm Window							
	Start Time HH:MM							
	Stop Time HH:MM							
2	Disarm Window							
	Start Time HH:MM							
	Stop Time HH:MM							
	Arm Window							
	Start Time HH:MM							
	Stop Time HH:MM							

Partition/Windows		Mon	Tue	Wed	Thu	Fri	Sat	Sun
3	Disarm Window							
	Start Time HH:MM							
	Stop Time HH:MM							
	Arm Window							
	Start Time HH:MM							
	Stop Time HH:MM							
4	Disarm Window							
	Start Time HH:MM							
	Stop Time HH:MM							
	Arm Window							
	Start Time HH:MM							
	Stop Time HH:MM							
5	Disarm Window							
	Start Time HH:MM							
	Stop Time HH:MM							
	Arm Window							
	Start Time HH:MM							
	Stop Time HH:MM							
6	Disarm Window							
	Start Time HH:MM							
	Stop Time HH:MM							
	Arm Window							
	Start Time HH:MM							
	Stop Time HH:MM							
7	Disarm Window							
	Start Time HH:MM							
	Stop Time HH:MM							
	Arm Window							
	Start Time HH:MM							
	Stop Time HH:MM							
8	Disarm Window							
	Start Time HH:MM							
	Stop Time HH:MM							
	Arm Window							
	Start Time HH:MM							
	Stop Time HH:MM							

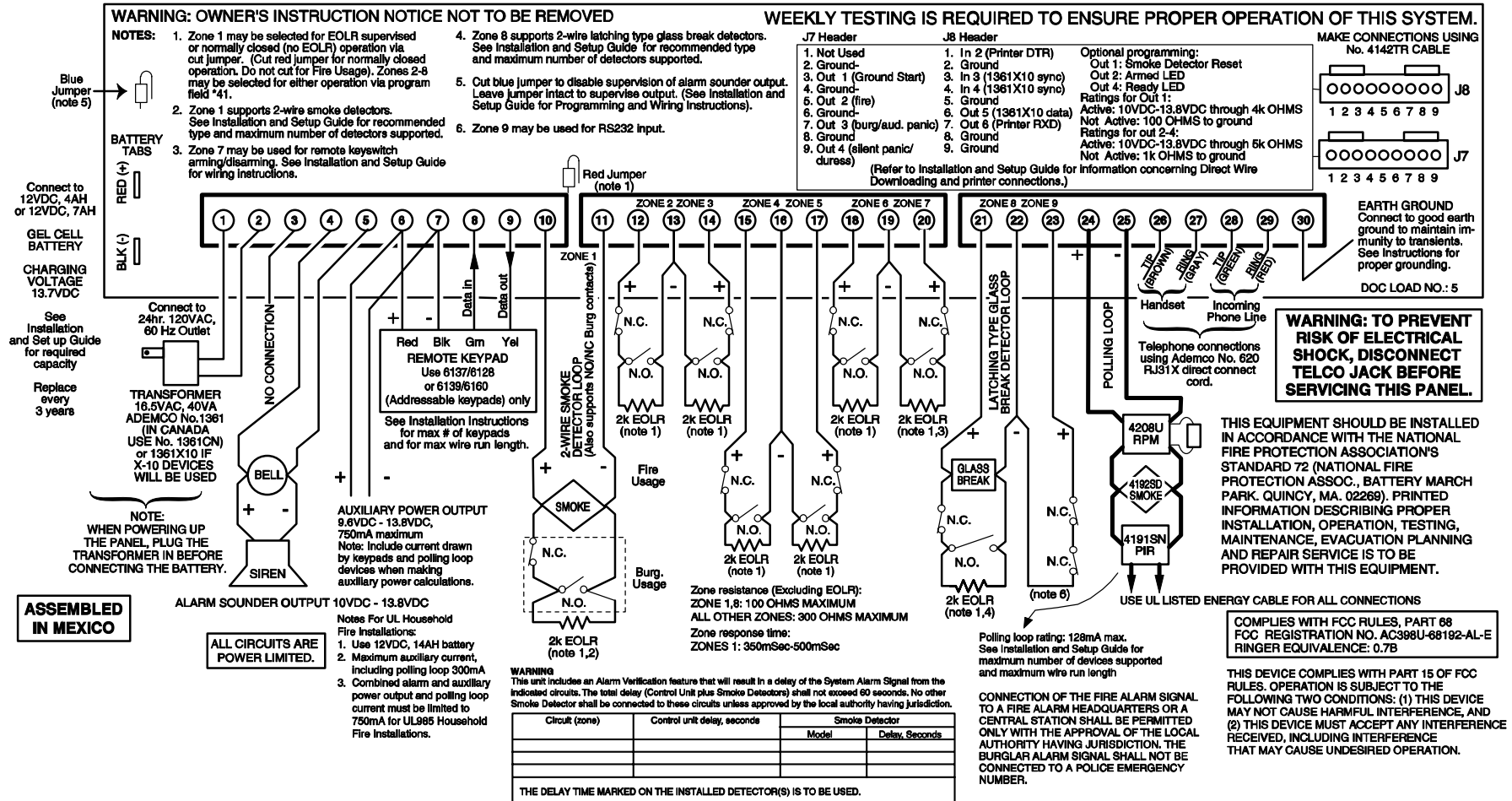

ADEMCO VISTA-128BP SUMMARY OF CONNECTIONS

WARNING: OWNER'S INSTRUCTION NOTICE NOT TO BE REMOVED

- NOTES:**
- Zone 1 may be selected for EOLR supervised or normally closed (no EOLR) operation via cut jumper. (Cut red jumper for normally closed operation. Do not cut for Fire Usage). Zones 2-8 may be selected for either operation via program field *41.
 - Zone 1 supports 2-wire smoke detectors. See Installation and Setup Guide for recommended type and maximum number of detectors supported.
 - Zone 7 may be used for remote keyswitch arming/dearming. See Installation and Setup Guide for wiring instructions.

- Zone 8 supports 2-wire latching type glass break detectors. See Installation and Setup Guide for recommended type and maximum number of detectors supported.
- Cut blue Jumper to disable supervision of alarm sounder output. Leave jumper intact to supervise output. (See Installation and Setup Guide for Programming and Wiring Instructions).
- Zone 9 may be used for RS232 input.

WEEKLY TESTING IS REQUIRED TO ENSURE PROPER OPERATION OF THIS SYSTEM.

- J7 Header**
- Not Used
 - Ground
 - Out 1 (Ground Start)
 - Ground
 - Out 2 (fire)
 - Ground
 - Out 3 (burg/aud. panic)
 - Ground
 - Out 4 (silent panic/duress)
- J8 Header**
- In 2 (Printer DTR)
 - Ground
 - In 3 (1361X10 sync)
 - In 4 (1361X10 sync)
 - Ground
 - Out 5 (1361X10 data)
 - Out 6 (Printer RXD)
 - Ground
 - Ground
- (Refer to Installation and Setup Guide for information concerning Direct Wire Downloading and printer connections.)

- Optional programming:**
- Out 1: Smoke Detector Reset
 - Out 2: Armed LED
 - Out 4: Ready LED
- Ratings for Out 1:**
- Active: 10VDC-13.8VDC through 4k OHMS
 - Not Active: 100 OHMS to ground
- Ratings for out 2-4:**
- Active: 10VDC-13.8VDC through 5k OHMS
 - Not Active: 1k OHMS to ground

MAKE CONNECTIONS USING No. 4142TR CABLE

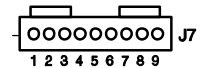
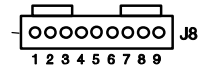

EARTH GROUND
Connect to good earth ground to maintain immunity to transients. See Instructions for proper grounding.

DOC LOAD NO.: 6

WARNING: TO PREVENT RISK OF ELECTRICAL SHOCK, DISCONNECT TELCO JACK BEFORE SERVICING THIS PANEL.

THIS EQUIPMENT SHOULD BE INSTALLED IN ACCORDANCE WITH THE NATIONAL FIRE PROTECTION ASSOCIATION'S STANDARD 72 (NATIONAL FIRE PROTECTION ASSOC., BATTERYMARCH PARK, QUINCY, MA. 02269). PRINTED INFORMATION DESCRIBING PROPER INSTALLATION, OPERATION, TESTING, MAINTENANCE, EVACUATION PLANNING AND REPAIR SERVICE IS TO BE PROVIDED WITH THIS EQUIPMENT.

THIS DEVICE COMPLIES WITH PART 15 OF FCC RULES. OPERATION IS SUBJECT TO THE FOLLOWING TWO CONDITIONS: (1) THIS DEVICE MAY NOT CAUSE HARMFUL INTERFERENCE, AND (2) THIS DEVICE MUST ACCEPT ANY INTERFERENCE RECEIVED, INCLUDING INTERFERENCE THAT MAY CAUSE UNDESIRABLE OPERATION.

CONNECTION OF THE FIRE ALARM SIGNAL TO A FIRE ALARM HEADQUARTERS OR A CENTRAL STATION SHALL BE PERMITTED ONLY WITH THE APPROVAL OF THE LOCAL AUTHORITY HAVING JURISDICTION. THE BURGLAR ALARM SIGNAL SHALL NOT BE CONNECTED TO A POLICE EMERGENCY NUMBER.

Polling loop rating: 128mA max. See Installation and Setup Guide for maximum number of devices supported and maximum wire run length

Blue Jumper (note 5)

BATTERY TABS

RED (+)

BLK (-)

Connect to 12VDC, 4AH or 12VDC, 7AH

GEL CELL BATTERY

CHARGING VOLTAGE 13.7VDC

See Installation and Setup Guide for required capacity

Replace every 3 years

Connect to 24hr. 120VAC, 60 Hz Outlet

TRANSFORMER 16.5VAC, 40VA ADEMCO No.1361 (IN CANADA USE No. 1361CN) or 1361X10 IF X-10 DEVICES WILL BE USED

NOTE: WHEN POWERING UP THE PANEL, PLUG THE TRANSFORMER IN BEFORE CONNECTING THE BATTERY.

ASSEMBLED IN MEXICO

ALARM SOUNDER OUTPUT 10VDC - 13.8VDC

Notes For UL Household Fire Installations

- Use 12VDC, 14AH battery
- Maximum auxiliary current, including polling loop 300mA
- Combined alarm and auxiliary power output and polling loop current must be limited to 750mA for UL985 Household Fire Installations.

COMPLIES WITH FCC RULES, PART 68 FCC REGISTRATION NO. AC398U-68192-AL-E RINGER EQUIVALENCE: 0.7B

ALL CIRCUITS ARE POWER LIMITED.

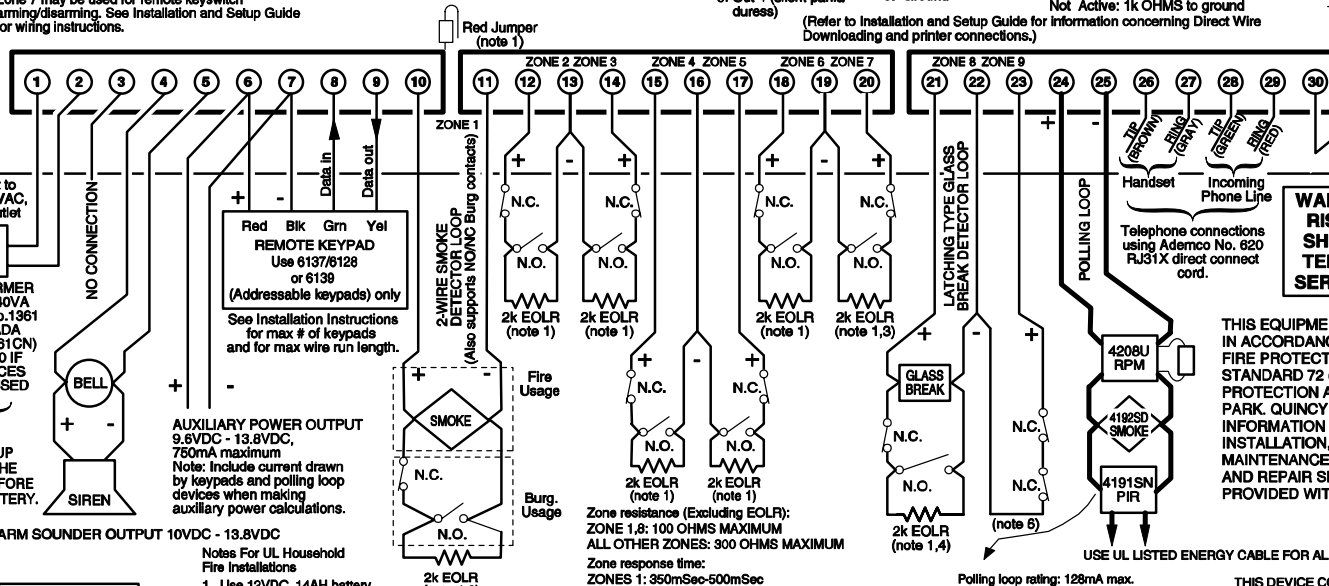

WARNING

This unit includes an Alarm Verification feature that will result in a delay of the System Alarm Signal from the indicated circuits. The total delay (Control Unit plus Smoke Detectors) shall not exceed 60 seconds. No other Smoke Detector shall be connected to these circuits unless approved by the local authority having jurisdiction.

Circuit (zone)	Control unit delay, seconds	Smoke Detector	
		Model	Delay, Seconds

THE DELAY TIME MARKED ON THE INSTALLED DETECTOR(S) IS TO BE USED.

ADEMCO VISTA-250BP SUMMARY OF CONNECTIONS

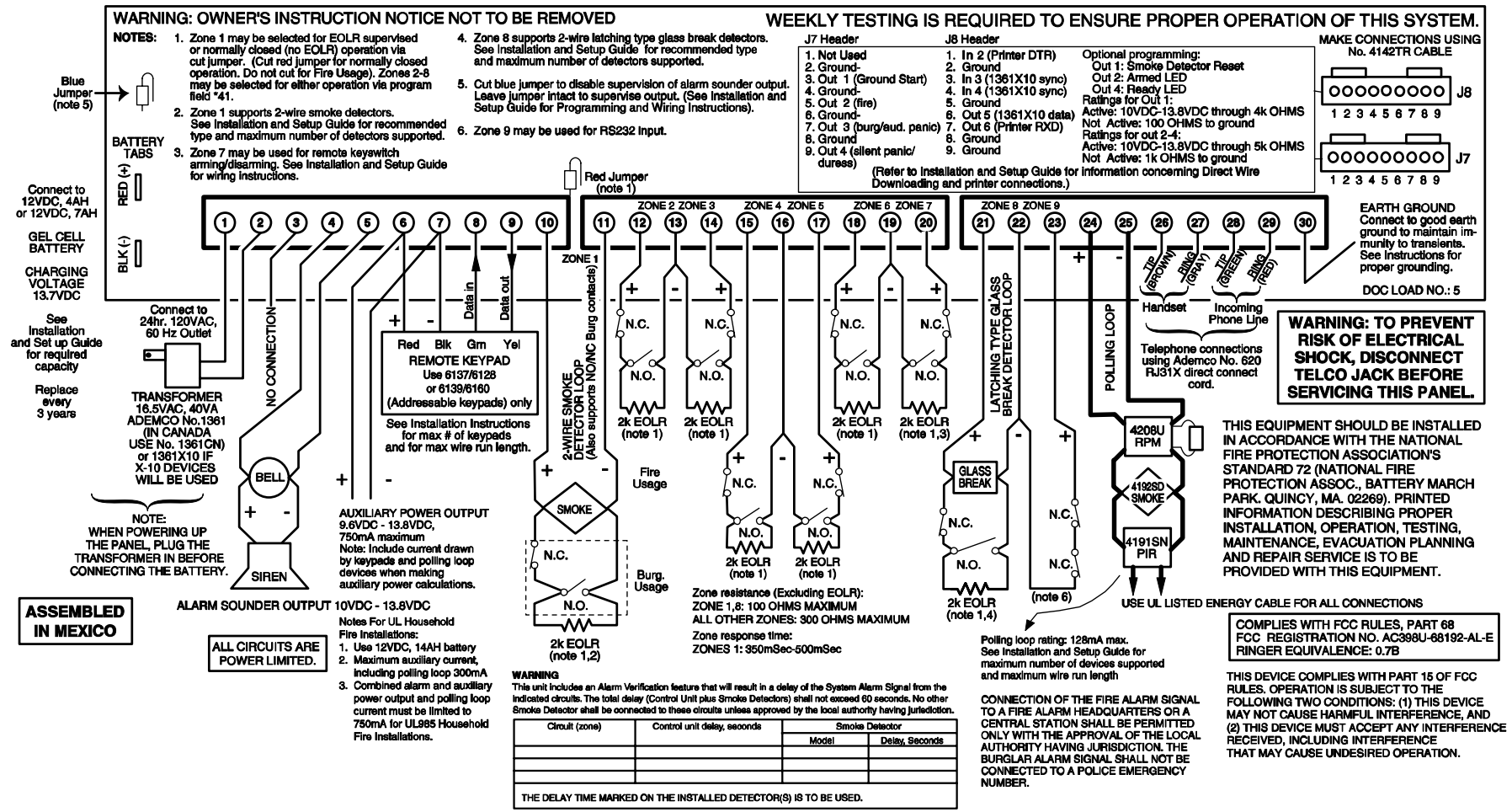

ADEMCO VISTA-128SIA SUMMARY OF CONNECTIONS

Honeywell

165 Eileen Way, Syosset, New York 11791
Copyright © 2004 Honeywell International Inc.

www.honeywell.com/security



K5894PRV4 6/04 Rev A